



MAUI[®] G3 MIX SERIES

COMPACT CARDIOID COLUMN PA SYSTEM WITH DIGITAL MIXER

LDMAUI11G3MIX(W); LDMAUI28G3MIX(W);

TABLE OF CONTENTS

1	DOCUMENT VERSIONS AND REVISIONS	7
2	INTRODUCTION	8
2.1	You Made the Right Choice!	8
2.2	Contacts.....	8
2.3	Link to the Download Centre.....	8
2.4	Visualisation Conventions in This User Manual.....	9
3	PRODUCT COMPLIANCE	10
3.1	Manufacturer's Declaration.....	10
3.2	Declaration of Conformity	10
4	SAFETY INSTRUCTIONS.....	12
4.1	Intended Use	12
4.2	Explanation of Safety and Warning Symbols.....	12
4.3	Structure of Warning Messages.....	13
4.4	General Safety	13
4.5	Electrical Safety.....	14
4.6	Physical Safety	14
4.7	Thermal Safety	15
4.8	Wireless Safety.....	15
4.9	Device Safety.....	15
5	PRODUCT DESCRIPTION	16
5.1	Product Overview	16
5.2	Product Variants.....	16
5.3	Optional Accessories.....	16
5.4	Dimensions.....	17
5.5	Technical Data	17
5.6	The User Interface.....	20
5.7	Easy Mode and Expert Mode	21
6	PREPARATION	22
6.1	Scope of Delivery	22

6.2	Component Overview.....	22
6.3	Assembling the Device	23
7	OPERATION.....	25
7.1	Power Supply.....	25
7.1.1	Power Connections	25
7.1.2	Connecting a Mains Power Cable.....	25
7.1.3	Turning the Device on or off.....	26
7.1.4	Disconnecting a Mains Power Cable	26
7.2	Navigating the Device	27
7.2.1	Navigating the Display.....	27
7.2.2	Using the Page Button.....	28
7.3	Mobile App	28
7.3.1	Downloading the Mobile App	28
7.3.2	App Extended Functionality	29
7.3.3	Updating the Firmware	30
7.4	Idle Screen Overview.....	31
7.5	Expert Mode Overviews	32
7.5.1	Input Channel Overviews Expert Mode.....	32
7.5.1.1	Input Metering Section Overview Expert Mode.....	32
7.5.1.2	PREAMP Section Overview.....	33
7.5.1.3	Channel EQ Section Overview Expert Mode.....	34
7.5.1.4	GATE Section Overview	35
7.5.1.5	COMPRESSOR Section Overview.....	36
7.5.1.6	SENDS Section Overview Mono.....	37
7.5.1.7	SENDS Section Overview Stereo.....	38
7.5.2	Main Channel Overviews Expert Mode.....	39
7.5.2.1	Main Metering Section Overview.....	39
7.5.2.2	MAIN EQ Section Overview.....	40
7.5.2.3	MONITOR OUT Section Mono Overview	41
7.5.2.4	MONITOR OUT Section Stereo Overview	42
7.5.2.5	Effects (FX).....	42
7.5.2.6	SYSTEM OUT Section Overview.....	43
7.5.3	FX Section Overview Expert Mode.....	44

7.5.3.1	FX Reverb Overview	44
7.5.3.2	FX Delay Overview	45
7.5.3.3	FX Chorus Overview	46
7.5.3.4	FX Combo Overview	47
7.5.4	Settings Section Overview Expert Mode.....	48
7.5.4.1	GLOBAL Settings Overview.....	48
7.5.4.2	App Access Overview.....	49
7.5.4.3	Footswitch Settings Overview.....	50
7.5.4.4	Display Settings Overview.....	51
7.5.4.5	System Settings Overview	52
7.5.4.6	Amp Section Overview.....	53
7.6	Easy Mode Overviews.....	53
7.6.1	Input Channel Overviews Easy Mode.....	54
7.6.1.1	EQ Section Overview Easy Mode.....	54
7.6.1.2	Config Overview Easy Mode	55
7.6.2	Main Channel Overviews Easy Mode.....	56
7.6.2.1	MAIN EQ Section Overview Easy Mode.....	56
7.6.2.2	FX Section Overview Easy Mode	57
7.7	Input Connections.....	58
7.7.1	Connecting an Input Source to the MIC / LINE / HI-Z Input.....	58
7.7.2	Bluetooth®	58
7.7.2.1	About Bluetooth® and Bluetooth® Low Energy (BLE)	58
7.7.2.2	Pairing a Device via Bluetooth® for Audio Playback	58
7.7.2.3	Unpairing a Bluetooth® Audio Playback Device.....	59
7.7.2.4	Pairing a Bluetooth® Low Energy (BLE) Device.....	59
7.8	Audio Playback.....	60
7.8.1	Adjusting the PREAMP Gain.....	60
7.8.2	Adjusting the Channel Volume.....	60
7.8.3	Adjusting the Main Volume	60
7.8.4	Using the Footswitch	61
7.8.5	Presets.....	61
7.9	Output Connections	62
7.9.1	SysLink®	62

7.9.1.1	Connecting a MAUI® System via SysLink®	62
7.9.1.2	Resetting SysLink® Devices to Default Settings.....	63
7.9.1.3	Setting Left (L) and Right (R) on a MAUI System connected via SysLink®	64
7.9.1.4	Remote-controlling a SysLink® Device.....	64
7.9.2	System Out	65
7.9.2.1	System Out Use Cases.....	65
7.9.2.2	Using the System Out.....	67
8	MAINTENANCE	68
8.1	Cleaning the Device	68
8.2	Storing the Device.....	68
8.3	Troubleshooting.....	69
8.4	Resetting the Device to Default Settings	70
8.5	Fail-Safe Recovery Mode.....	71
8.5.1	Starting the Device in Fail-Safe Recovery Mode.....	71
9	REPAIR.....	72
10	DISPOSAL	73
10.1	Packaging Disposal	73
10.2	Device Disposal.....	73
	INDEX	74

1 | DOCUMENT VERSIONS AND REVISIONS

Version Number	Version	Changes	Publishing Date
1	This document	Original	January 2025

2 | INTRODUCTION

2.1 YOU MADE THE RIGHT CHOICE!

This product has been developed and manufactured to the highest quality standards to ensure many years of problem-free operation. Find further information about LD Systems on our website:

<https://www.ld-systems.com/>

2.2 CONTACTS

	Adam Hall GmbH Headquarter	Customer Service
E-mail	info@adamhall.com	customerservice@adamhall.com
Phone	+49 6081 9419-0	+49 6081 941973-0
Street	Adam-Hall-Str. 1	Adam-Hall-Str. 1
Postal code / city	61267 Neu-Anspach	61267 Neu-Anspach
Website	www.adamhall.com	www.adamhall.com

2.3 LINK TO THE DOWNLOAD CENTRE

You can download some information, such as CAD data or technical data, from the Download Centre. Scan the QR code or click the link to download this information:

[*MAUI® 11 G3 MIX*](#) [*MAUI® 28 G3 MIX*](#)



Maui 11 G3 Mix



Maui 28 G3 Mix

2.4 VISUALISATION CONVENTIONS IN THIS USER MANUAL

In this user manual we use graphical symbols and icons in certain contexts. Find below a table with explanations and use cases of the graphical symbols and icons.

Icon / Symbol	Designation	Context	Explanation / Example
✓	Prerequisite	Tasks	Used in task topics to indicate a prerequisite that must be met before beginning the task.
⇒	Result / Intermediate Result	Tasks	Used in task topics to indicate a result or intermediate result of an action step.
1 Step a) Substep	1 Action Step a) Substep	Tasks	Used in task topics to indicate action steps and substeps.
1	Callout	Graphics; tasks	Text-image reference or labeling of certain functions on the device
[...]	Value range indicator	Technical data; paragraphs; lists	Indicates the range of a value, such as "Compressor ratio: 1:1...20:1 ". Mostly used in tables or callouts.
*	Asterisk	Paragraphs; tables	Indicates additional information in a footnote.
The LIM LED lights up	General User Interface element	Paragraphs; tasks; tables; lists	The words presented in this way represent graphic user interface elements on the device.
PAGE button	Key / Button	Paragraphs; tasks; tables; lists	The words presented in this way represent user interface controls on the device.
<name>	User input	Paragraphs; tasks; tables; lists	The words presented in this way represent required user inputs.
<u>https://adamhall.com</u>	Weblink	Paragraphs; tables; lists	External link to a website

3 | PRODUCT COMPLIANCE

3.1 MANUFACTURER'S DECLARATION

Adam Hall offers a voluntary, EU-wide manufacturer's guarantee of 2 years. The statutory warranty period is not affected by this voluntary guarantee.

You can find our current detailed warranty conditions and limitation of liability at:

<https://www.adamhall.com/manufacturers-declarations-ld-systems>

To request warranty for a product, please contact:

Adam Hall GmbH, Adam-Hall-Str. 1, 61267 Neu Anspach

customerservice@adamhall.com

0049 (0)6081 / 9419-1000.

3.2 DECLARATION OF CONFORMITY



Hereby, Adam Hall Ltd. declares that this product meets the following guidelines (where applicable)

- Electrical Equipment (Safety) Regulations 2016
- Electromagnetic Compatibility Regulations 2016 (SI 2016/1091)
- The Restriction of the Use of Certain Hazardous Substances in Electrical and Electronic Equipment Regulation 2012 (SI 2012/3032)
- Radio Equipment Regulations 2017 (SI 2016/2015)

Products that are subject to Electrical Equipment(Safety)Regulation 2016, EMC Regulation 2016 or RoHS Regulation can be requested at info@adamhall.com. Products that are subject to the Radio Equipments Regulations 2017 (SI2017/1206) can be downloaded at <http://www.adamhall.com/compliance>.

FCC STATEMENT



This device complies with part 15 of the FCC Rules. Operation is subject to the following two conditions:

1. This device may not cause harmful interference.
2. This device must accept any interference received, including interference that may cause undesired operation.

CAUTION! RF Exposure Information: This equipment complies with FCC radiation exposure limits set forth for an uncontrolled environment. This equipment should be installed and operated with minimum distance 20cm between the radiator and your body.

CAUTION! Any changes or modifications to this device not explicitly approved by the manufacturer could void your authority to operate this equipment.

This equipment has been tested and found to comply with the limits for a Class B digital device, pursuant to part 15 of the FCC Rules. These limits are designed to provide reasonable protection against harmful interference in a residential installation. This equipment generates, uses and can radiate radio frequency energy and, if not installed and used in accordance with the instructions, may cause harmful interference to radio communications. However, there is no guarantee that interference will not occur in a particular installation. If this

equipment does cause harmful interference to radio or television reception, which can be determined by turning the equipment off and on, the user is encouraged to try to correct the interference by one or more of the following measures:

- Reorient or relocate the receiving antenna.
- Increase the separation between the equipment and receiver.
- Connect the equipment into an outlet on a circuit different from that to which the receiver is connected to.
- Consult the dealer or an experienced radio/TV technician for help.

ISED STATEMENT

This device contains licence-exempt transmitter(s)/receiver(s) that comply with Innovation, Science and Economic Development Canada's licence-exempt RSS(s). Operation is subject to the following two conditions:

1. This device may not cause interference.
2. This device must accept any interference, including interference that may cause undesired operation of the device.

The digital apparatus complies with Canadian CAN ICES-003 (B)/NMB-003(B).

This equipment complies with IC RSS-102 radiation exposure limits set forth for an uncontrolled environment.

This equipment should be installed and operated with minimum distance 20cm between the radiator and your body.

This device meets the exemption from the routine evaluation limits in section 2.5 of RSS 102 and compliance with RSS 102 RF exposure, users can obtain Canadian information on RF exposure and compliance.

4 | SAFETY INSTRUCTIONS

4.1 INTENDED USE

This product has been developed for the professional use in the field of event technology. Furthermore it is intended for qualified users with specialist knowledge of event technology only.

The device is intended for mobile applications and not for fixed installations. The device is not suitable for continuous electrical operation.

The device is intended for indoor use only.

It is not suitable for domestic use.

Do not use the product outside the operating conditions as stated in the user manual under Technical Data. Liability for damage and third-party damage to persons and property due to inappropriate use is excluded.

This product is not suitable for children and persons with limited physical, sensory, or mental capabilities or lack of experience and knowledge.

4.2 EXPLANATION OF SAFETY AND WARNING SYMBOLS

Find the following safety and warning symbols on the device, the user manual, or the packaging:



This symbol indicates that you must read the complete user manual before using the product.



This symbol indicates a general hazardous situation.



This symbol indicates hazards that can cause electric shock.



This symbol indicates tripping hazards.



This symbol indicates high sound pressure levels.



This symbol indicates pinching hazards.



This symbol indicates that the product is for indoor use only.



This symbol indicates that the product is not suitable for household use.



This symbol indicates that the product has no serviceable parts. Only authorized personnel is allowed to perform maintenance or service work.



This symbol indicates helpful hints or additional information.

4.3 STRUCTURE OF WARNING MESSAGES

In this user manual, warning messages are structured with a safety symbol, a signal word, a hazard description, and instructions on how to avoid injuries or death.



DANGER

Indicates a hazardous situation which will result in death or serious injury.



WARNING

Indicates a hazardous situation which could result in death or serious injury



CAUTION

Indicates a hazardous situation which could result in minor or moderate injury.



NOTICE

Indicates situations or conditions that could result in damage to property and/or the environment.

4.4 GENERAL SAFETY



- Read this user manual carefully.
- Keep this user manual for later reference.
- Follow closely the instructions in this user manual.
- This user manual is an integral part of the product. If you sell or pass on the product, you must include this user manual.
- Only use this device according to its intended use.
- This device is for professional use only.
- Observe all safety instructions and warning messages in this user manual, on the device, and on the packaging.
- Devices are subject to continuous further development. If you find discrepancies between the user manual and the device labeling, the information on the device always takes priority.
- Do not remove safety instructions or warning messages from the device.
- Do not open the device.
- Do not modify the device.
- If the device shows any sign of damage, do not use it.
- Do not operate the device with removed or missing covers.
- Do not expose the device to direct sunlight.
- If not further specified in the user manual under Technical Data, do not use the device in ambient temperatures that exceed 40°C / 104°F or fall below 0°C / 32°.
- Do not use the device in tropical climate.

- Do not use the device above 2000m of altitude.
- Unless otherwise stated, do not use under marine conditions.
- Use only accessories specified by the manufacturer.
- Maintenance and repairs may only be carried out by authorized service personnel.
- Store and transport the device in a dry and safe environment.
- If the device was exposed to strong temperature changes, such as during transport, do not switch it on immediately. Wait until the device has reached ambient temperature.
- High sound pressure levels may cause hearing damage. Avoid prolonged exposure to high sound pressure levels. Wear hearing protection.
- Risk of hearing damage. Plugging or unplugging devices in the signal chain may cause an audio signal peak. Switch on the loudspeaker as the last device in the signal chain.
- Risk of hearing damage. Switching on or off other devices in the signal chain may cause an audio signal peak. Switch on the loudspeaker as the last device in the signal chain.

4.5

ELECTRICAL SAFETY



- This device is a Class I electrical device. Make sure that the protective conductor is connected to electrical earth. Do not disconnect or bypass the protective conductor.
- Do not bypass the mains fuse.
- Use only mains fuses as specified by the manufacturer.
- Do not use kinked or otherwise damaged power cables.
- Only operate the device on compliant, tested and intact mains power outlets.
- Do not use the device in the vicinity of water. Keep the device away from splashing or dripping water.
- Make sure that the voltage and frequency of the mains power match the values specified by the manufacturer.
- Take suitable measures against overvoltage, such as lightning strikes.
- For devices with a power out connector, make sure the total current consumption of all connected devices does not exceed the value specified by the manufacturer.
- This device is not suitable for continuous current.
- Disconnect the device from all poles before maintenance, repair or extend periods of non-use.
- Permanently connected power cables may only be replaced by a qualified service technician.

4.6

PHYSICAL SAFETY



- Make sure that the device and its stand are securely positioned. Secure against unintentional movement.
- Check all cable routes to prevent tripping accidents.
- Moving components, such as mounting brackets, pose a risk of pinching injuries.

4.7 THERMAL SAFETY

- Do not install the device near heat sources, such as radiators or ovens.
- Do not block any ventilation openings.
- Unless otherwise stated, keep a minimum clearance of at least 20 centimetres around the device.
- Unless otherwise stated, keep flammable materials, such as paper or wood, at least 50 centimetres away from the device

4.8 WIRELESS SAFETY



Radio transmitter operation is subject to official regulations. Make sure you adhere to regional guidelines before commissioning.

Radio operation can lead to potentially dangerous effects. Do not use this device in sensitive areas such as:

- Hospitals, health centres or other healthcare facilities that provide patient treatment with skilled personnel and equipment
- Hazardous areas Class I, II and III
- Restricted areas
- Military facilities
- Areas where the use of mobile phones is prohibited, such as aircrafts.

Quality and performance of wireless signal transmissions is dependent on the environmental conditions. All range specifications refer to free-field application with visual contact without interference. Range and signal stability may be influenced by:



- Shielding, such as masonry, metal buildings, or water
- Interference
- High radio traffic, such as strong W-LAN networks
- Electromagnetic radiation, such as LED video walls or dimmers

4.9 DEVICE SAFETY



- Do not switch the device on and off in quick succession, because this will shorten the device lifetime.
- Loudspeakers generate a magnetic field, even when they are not in use. Devices, such as hard disk drives or cheque cards may be affected by the loudspeaker's magnetic field. Do not set up or transport these devices near the loudspeaker.

5 | PRODUCT DESCRIPTION

5.1 PRODUCT OVERVIEW

The LD Systems **MAUI® G3 MIX** Series is a portable cardioid column PA system with digital mixer.

FEATURES:

- Integrated digital 6-channel mixer with on-board effects, dynamics and footswitch input
- Bluetooth® audio streaming
- App Control
- Easy and Expert Mode
- **SysLink®** (cascading of two **MAUI®** systems)

5.2 PRODUCT VARIANTS

The LD Systems **MAUI® G3 MIX** Series offers the following product variants. Each variant is available in black and white RAL 9003.

- LDMAUI11G3MIX - Powered system with 2 x 8" subwoofers, 6 x 3.5" full-range loudspeakers, 2 x 1" high-frequency drivers with Bluetooth® and app control.
- LDMAUI28G3MIX - Powered system with 12" subwoofer, 12 x 3,5" full-range loudspeakers and 2 x 1" high-frequency drivers with Bluetooth® and app control.

5.3 OPTIONAL ACCESSORIES

Find various accessories for your product in the Adam Hall Shop:

<https://www.adamhall.com/shop>

Accessory	MAUI11G3MIX	MAUI28G3MIX
Network cable	4 STAR ECON CAT6A 10m / 30m Article number: K4CAT61000 / K4CAT63000	
Protective cap for MAUI® G3 MIX subwoofer	MAUI® SUB CAP Article number: LDMG3SUBC	
Powered 2 x 8" subwoofer	MAUI® 11 G3 SUB Article number: LDM11G3SUB	-
Powered 12" subwoofer	-	MAUI® 28 G3 SUB Article number: LDM28G3SUB
Padded protective cover for MAUI® G3 MIX subwoofer	MAUI® 11 G3 PC Article number: LDM11G3SUBPC	MAUI® 28 G3 PC Article number: LDM28G3SUBPC
Castor board for MAUI® G3 MIX subwoofer	MAUI® 11 G3 CB Article number: LDM11G3CB	MAUI® 28 G3 CB Article number: LDM28G3CB

Accessory	MAUI11G3MIX	MAUI28G3MIX
Padded carrying bag for MAUI® G3 MIX columns	MAUI® 11 G3 SAT BAG Article number: LDM11G3SATBAG	MAUI® 28 G3 SAT BAG Article number: LDM28G3SATBAG

5.4 DIMENSIONS

Visit the download centre to download the product dimensions as a CAD file.

See also:

[Link to the Download Centre \[▶ 8\]](#)

5.5 TECHNICAL DATA

GENERAL

Article number	LDMAUI11G3MIX(W)	LDMAUI28G3MIX(W)
Product type	PA complete system	PA complete system
Power type	Powered	Powered
Housing colour	Black / white (RAL 9003)	Black / white (RAL 9003)
Max SPL (Peak)	125 dB	127 dB
Frequency response (-10dB)	39 Hz...20 kHz	37 Hz...20 kHz
Dispersion (H x V)	120° x 30°	120° x 30°
Weight	31.5 kg	36.2 kg
Features	Bluetooth® audio streaming, cardioid column, app control (Easy Mode + Expert Mode), 6-channel mixer, footswitch input, SysLink® (cascading of 2 systems), built-in effects + dynamics	Bluetooth® audio streaming, cardioid column, app control (Easy Mode + Expert Mode), 6-channel mixer, footswitch input, SysLink® (cascading of 2 systems), built-in effects + dynamics

SUBWOOFER

Article number	LDMAUI11G3MIX(W)	LDMAUI28G3MIX(W)
Woofer size (inch)	2 x 8"	12"
Woofer size (mm)	2 x 203 mm	305 mm
Woofer magnet	Ferrite	Ferrite
Woofer brand	Custom-made	Custom-made
Woofer voice coil (inch)	2"	3"
Woofer voice coil (mm)	50.8 mm	76.2 mm

Article number	LDMAUI11G3MIX(W)	LDMAUI28G3MIX(W)
Cabinet design	Bass Reflex	Bass Reflex
Housing material	15 mm multiplex birch plywood	15 mm multiplex birch plywood
Housing protective coating	Polyurea	Polyurea
Dimensions	305 mm x 607 mm x 403 mm	370 mm x 527 mm x 472 mm
Weight	21.3 kg	23.6 kg

MID/HI SYSTEM

Article number	LDMAUI11G3MIX(W)	LDMAUI28G3MIX(W)
Midrange dimensions (inch)	6 x 3.5"	12 x 3.5"
Midrange dimensions (mm)	6 x 89 mm	12 x 89 mm
Midrange magnet	Ferrite	Ferrite
Midrange brand	Custom-made	Custom-made
Midrange voice coil (inch)	0.75"	0.75"
Midrange voice coil (mm)	19 mm	19 mm
Tweeter dimensions (inch)	2 x 1"	2 x 1"
Tweeter dimensions (mm)	2 x 25.4 mm	2 x 25.4 mm
Tweeter magnet	Neodymium	Neodymium
Tweeter brand	Custom-made	Custom-made
Tweeter voice coil (inch)	1"	1"
Tweeter voice coil (mm)	25.4 mm	25.4 mm
Wave Guide	CD waveguide	CD waveguide
Loudspeaker inputs	1	1
Loudspeaker input connections	Custom-made 14-pin	Custom-made 14-pin
Cabinet design mid/high	Passive cardioid	Passive cardioid
Mid/High system housing material	Aluminium	Aluminium
Mid/High system housing surface	Powder-coated aluminium	Powder-coated aluminium
Mid/High system width	103 mm	103 mm
Mid/High system height	1460 mm	1540 mm
Mid/High system depth	135 mm	135 mm
Mid/High system weight	10.2 kg	12.6 kg

AMPLIFIER MODULE (INTEGRATED IN SUBWOOFER)

Article number	LDMAUI11G3MIX(W)	LDMAUI28G3MIX(W)
Amplifier	Class D	Class D
System output	730 W (RMS) / 1460 W (Peak)	1030 W (RMS) / 2060 W (Peak)
Protection circuits	DC protection, short circuit, multi-band limiter, thermal protection	DC protection, short circuit, multi-band limiter, thermal protection
Cooling	Convection	Convection
Control elements	Page button, Bluetooth® HOLD TO LINK button, Input type, Main level, Power On/Off, Channel Level, Remote, Rotary-push encoder	Page button, Bluetooth® HOLD TO LINK button, Input type, Main level, Power On/Off, Channel Level, Remote, Rotary-push encoder
Indicators	Signal, input type, limit, remote, Bluetooth®, display, channel Level, mute, power, protect (protection circuit engaged)	Signal, input type, limit, remote, Bluetooth®, display, channel Level, mute, power, protect (protection circuit engaged)
Power connector	powerCON®	powerCON®
Operation voltage	100 V AC...120 V AC, 50...60 Hz, 220 V AC...240 V AC, 50...60 Hz	100 V AC...120 V AC, 50...60 Hz, 220 V AC...240 V AC, 50...60 Hz
Fuse	T 3.15AL / 250 V	T 5AL / 250 V
Power consumption	300 W	400 W
Ambient temperature (operating)	0°...40°C	0°...40°C
Relative humidity	< 80% (non-condensing)	< 80% (non-condensing)
Line inputs	4, Footswitch	4, Footswitch
Line input connectors	Combo XLR / TRS	Combo XLR / TRS
Line outputs	2 Monitor OUT, 1 System OUT	2 Monitor OUT, 1 System OUT
Line output connectors	XLR male	XLR male
Number of loudspeaker outputs	1	1
Loudspeaker output connectors	Custom-made multipin	Custom-made multipin
Bluetooth® standard	A2DP	A2DP
Bluetooth® audio decoder	SBC	SBC

DSP CHARACTERISTICS

Article number	LDMAUI11G3MIX(W)	LDMAUI28G3MIX(W)
AD/DA converter bit depth	24 Bit	24 Bit
AD/DA converter sampling frequency	48 kHz	48 kHz

5.6 THE USER INTERFACE

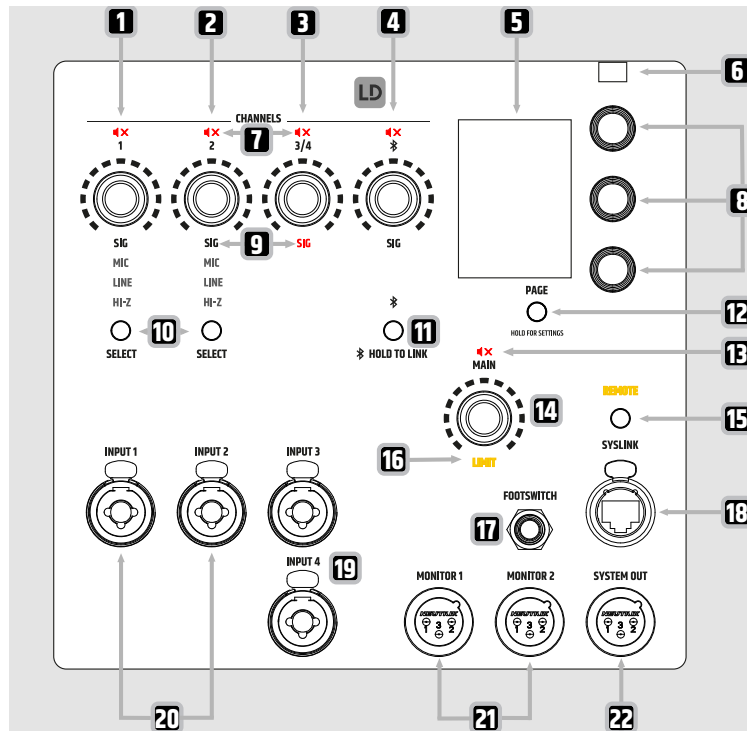

- 1 **Channel 1 Rotary-Push Encoder (RPE)** - Controls the volume and mute for channel 1. Hold to mute or unmute. Lights up orange in SysLink® remote mode.
- 2 **Channel 2 Rotary-Push Encoder (RPE)** - Controls the volume and mute for channel 2. Hold to mute or unmute. Lights up orange in SysLink® remote mode.
- 3 **Channel 3/4 Rotary-Push Encoder (RPE)** - Controls the volume and mute for channels 3/4. Hold to mute or unmute. Lights up orange in SysLink® remote mode.
- 4 **Channel BT Rotary-Push Encoder (RPE)** - Controls the volume of the Bluetooth® channel. Hold to mute or unmute. Lights up orange in SysLink® remote mode.
- 5 **LC Display** - Main graphic colour display. Display edges turn orange in SysLink® remote mode. For screensaver options, see the display settings.
- 6 **Brightness sensor** - Automatically adjusts the display brightness. Turn on or off in the display settings.
- 7 **Mute CHANNELS** - Indicates that the channel is muted
- 8 **Display Rotary-Push Encoders (RPE)** - Control the display menu items (Upper RPE, Mid RPE, Lower RPE)

- 9 **SIG** - Indicates that an audio signal is present at the corresponding channel (white LED). If the signal is clipping the LED turns red.
- 10 **SELECT buttons** - Toggle between MIC, LINE and HI-Z.
- 11 **HOLD TO LINK button** - Push and hold for 2 seconds to activate Bluetooth® pairing for audio streaming.
- 12 **PAGE button** - Browses through the menu pages. Hold for 1 second to access the settings.
- 13 **Mute MAIN** - Indicates that the main channel is muted
- 14 **MAIN Rotary-Push Encoder (RPE)** - Controls the main volume and mute for the main channel. Hold to mute or unmute. Lights up orange in SysLink® remote mode.
- 15 **SYSLINK button** - Push to access the remote unit connected via SysLink®
- 16 **LIMIT** - Indicates that the main limiter is active
- 17 **FOOTSWITCH** - Mutes and unmutes the internal effect module or the MAIN channel (6.3 mm TRS jack)
- 18 **SYSLINK socket** - RJ45 SysLink® socket
- 19 **INPUT 3/4** - Balanced XLR/jack combo sockets (3-pin XLR / 6.35 mm jack / 48 V phantom power not supported).
- 20 **INPUT 1 and 2** - Balanced XLR / jack combo sockets (3-pin XLR / 6.35 mm jack / 48V phantom power supported)
- 21 **MONITOR 1 and 2** - Audio output sockets (balanced 3-pin XLR) for external monitors
- 22 **SYSTEM OUT** - Audio output socket (balanced 3-pin XLR)

5.7 EASY MODE AND EXPERT MODE

The MAUI® G3 MIX System features an **Easy Mode** with a reduced user interface for beginner users. If you like to access the system's full functionality, activate the **Expert Mode**. The layout of some of the pages of the user interface differs from Easy Mode to Expert Mode. For an overview of the user interface layouts, refer to the overview sections in the user manual.

In Expert Mode and Easy Mode, volume levels are scaled differently. In Easy Mode, the decibel unit is not indicated.

EXAMPLE:

Expert Mode	-inf dB...+10.0 dB
Easy Mode	0...100

See also:

Expert Mode Overviews [▶ 32]

Easy Mode Overviews [▶ 53]

GLOBAL Settings Overview [▶ 48]

6 | PREPARATION

6.1 SCOPE OF DELIVERY

- Device
- Mains power cable
- Safety Compliance Information (en, de, fr, it, pl, es)
- Quick Start Guide (en)

6.2 COMPONENT OVERVIEW

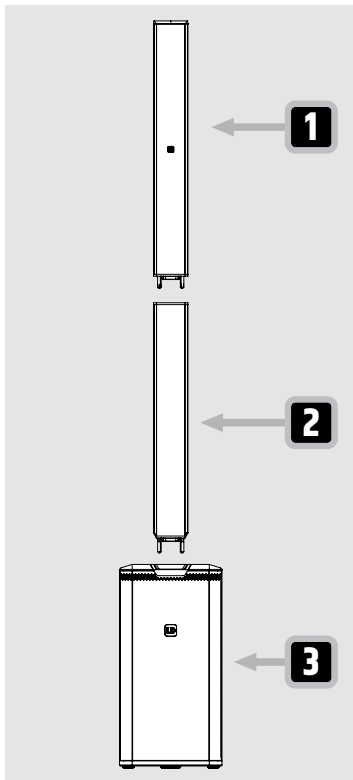

- 1 Upper array column** with 6x3.5" speakers, tweeter, and multipin connector on the bottom
- 2 Lower array column** with 6x3.5" speakers*, top and bottom 14-pin connectors.
- 3 Subwoofer** with integrated electronics

Only the MAUI® 28 G3 MIX has built-in loudspeakers in the lower array column **2. The MAUI® 11 G3 MIX does not.*

6.3 ASSEMBLING THE DEVICE

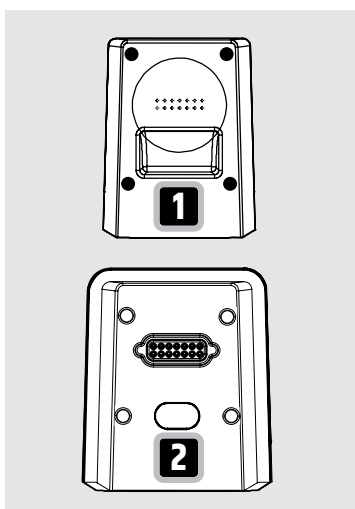

1 Connect the lower array column **1** to the subwoofer **2**.

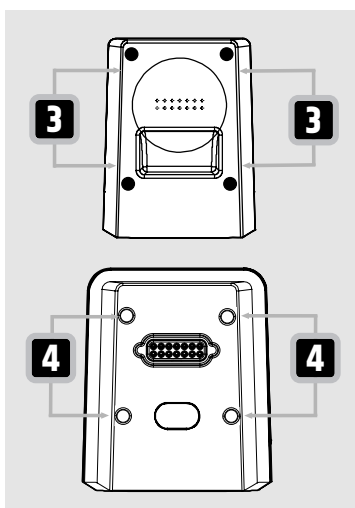

2 Insert the steel pins of the lower array column **3** into the steel pin holes of the subwoofer **4**.

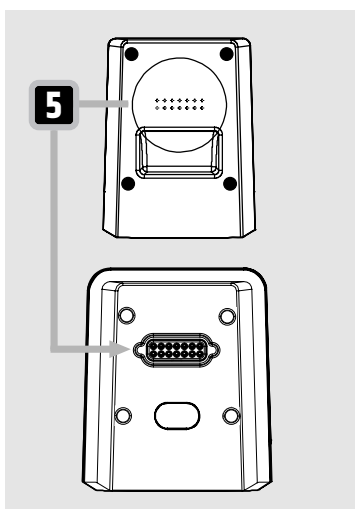

3 Make sure both components connect properly.
 ⇨ The 14-pin connectors **5** of the lower array column and the subwoofer are electrically connected.

- 4** Connect the upper array column to the lower array column:
 - a) Insert the steel pins of the upper array column into the steel pin holes of the lower array column.
 - b) Make sure both components connect properly.
 - ⇒ The 14-pin connectors of the upper and lower array column are electrically connected.

See also:
[Component Overview \[▶ 22\]](#)

7 | OPERATION

7.1 POWER SUPPLY

7.1.1 POWER CONNECTIONS

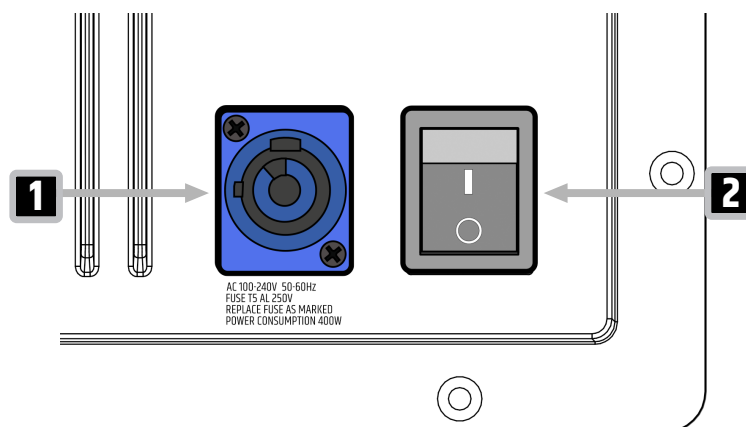

- 1 **POWER INPUT** - Device power socket
- 2 **POWER SWITCH** - On/off

7.1.2 CONNECTING A MAINS POWER CABLE



CAUTION

Mains voltage

Risk of electric shock

- a. Do not use kinked or damaged mains power cables.



NOTICE

Damage to the device

- a. Make sure that the voltage of the mains power socket matches the device operating voltage.
- b. Do not plug the device under load.

- 1 Plug the device power connector into the device. Make sure the bayonet connector is positioned correctly.
- 2 Turn the bayonet connector clockwise to lock it.
- 3 Plug the mains power connector into the mains power socket.

7.1.3 TURNING THE DEVICE ON OR OFF

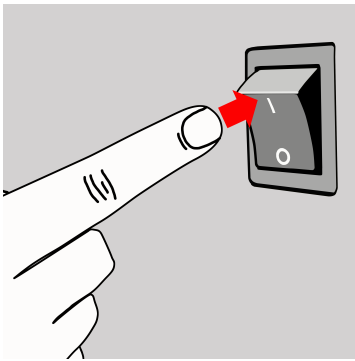

- 1** Flip the switch from the **O** to the **I** position.
 - ⇒ The display turns on and the device boots.
 - ⇒ After a few seconds, the device is operational.
- 2** Flip the switch from the **I** to the **O** position.
 - ⇒ The device turns off.

7.1.4 DISCONNECTING A MAINS POWER CABLE



NOTICE

Damage to the device

- a. Make sure that the voltage of the mains power socket matches the device operating voltage.
- b. Do not unplug the device under load:
 - i) Unplug the mains power connector of the mains power cable from the mains power socket first.
 - ii) Unplug the device power connector from the device power socket last.

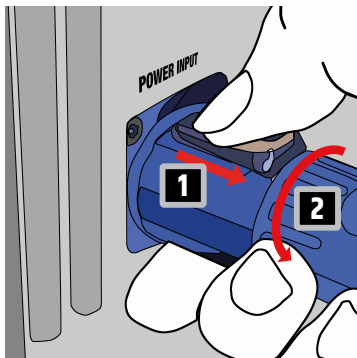

- 1** Disconnect the connector of the mains power cable from the mains power socket.
- 2** Pull the locking lever of the bayonet connector backwards and hold it. **1**
- 3** Turn the bayonet connector anticlockwise. **2**
- 4** Pull the bayonet connector out of the device power socket.

7.2 NAVIGATING THE DEVICE

7.2.1 NAVIGATING THE DISPLAY

If you're not using the **MAUI® G3 MIX** app, use the display **rotary-push encoders (RPE)** to access the menu items. Find the procedure to adjust the **PREAMP** gain and to set the **LOWCUT** to **100Hz** below as an example. The following applies to all settings:

- The menu follows a three-section structure. Each display **RPE** controls one of these sections. All other display pages follow the same structure.
- Push the **RPE** to switch back and forth between the menu items.
- Turn the **RPE** to adjust the values of the highlighted menu items.

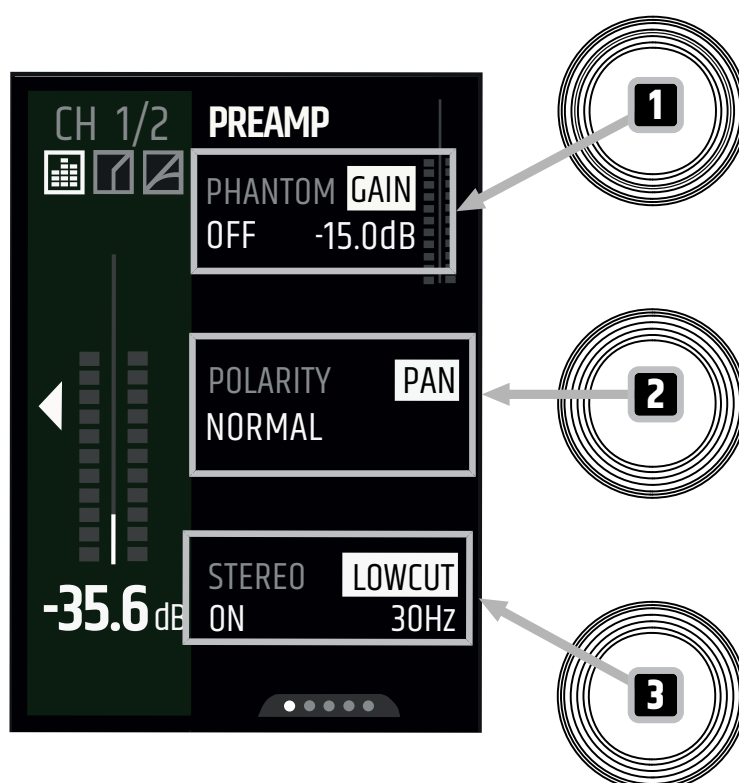

- 1 Push the channel **RPE** of channel 1.
 - ⇒ The display shows the channel strip of channel 1.
- 2 Push the **PAGE** button until the **PREAMP** page shows up.
- 3 Adjust the **PREAMP** gain:
 - a) Push the upper display **RPE** **1** to select **GAIN**.
 - b) Turn the upper display **RPE** clockwise to increase the gain and anticlockwise to decrease it.
 - ⇒ You adjusted the **PREAMP** gain.
- 4 Set the **LOWCUT** to **100Hz**:
 - a) Push the lower display **RPE** **3** to select **LOWCUT**.
 - b) Turn the lower display **RPE** to **100Hz**.
 - ⇒ You set the **LOWCUT** to **100Hz**.

7.2.2 USING THE PAGE BUTTON

- 1 Push the channel **rotary-push encoder (RPE)** of any channel.
 ⇒ The display shows the corresponding channel strip.

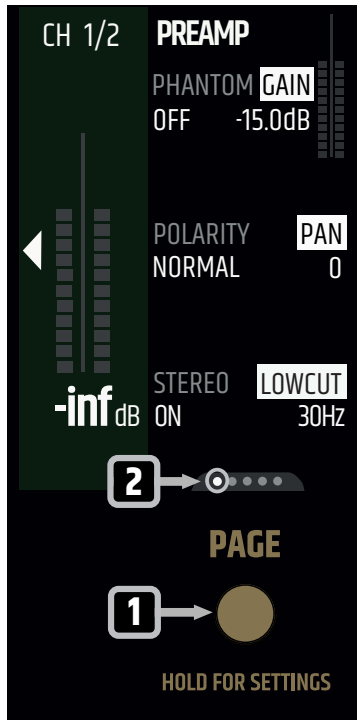

- 2 Push the **PAGE** button **1** to navigate to the next page on the right.

 The highlighted dot indicates the current page. **2**

 The **PAGE** button navigates to the right. When you reach the far right, pressing the **PAGE** button takes you back to the first page.

7.3 MOBILE APP

7.3.1 DOWNLOADING THE MOBILE APP



Visit the Apple App Store or the Google Play Store to download the device app for advanced functionality and features.

Please update via app for full functionality!

7.3.2 APP EXTENDED FUNCTIONALITY

The **MAUI® MIX** app provides access to additional features and makes using functions easier, such as presets, graphic EQ, and sends. For detailed instructions, see the **MAUI® MIX** app user manual.

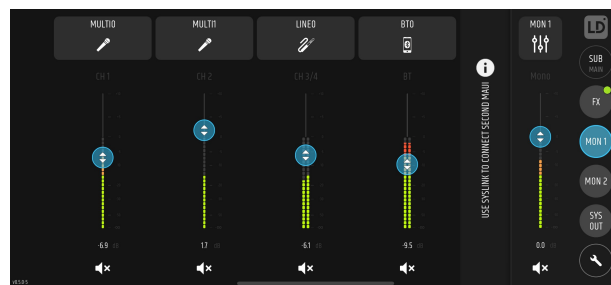
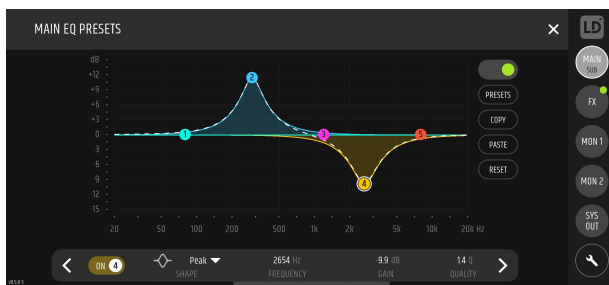
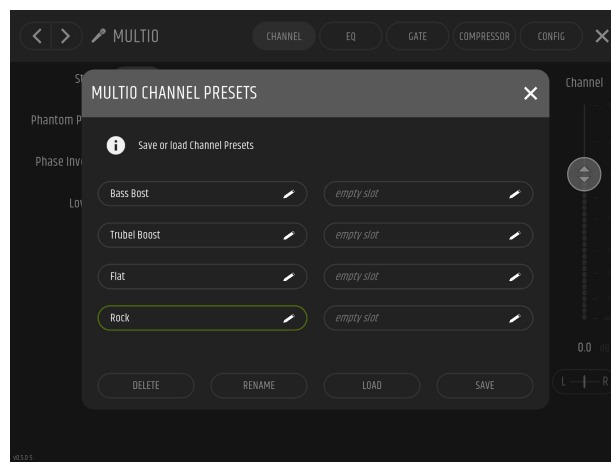
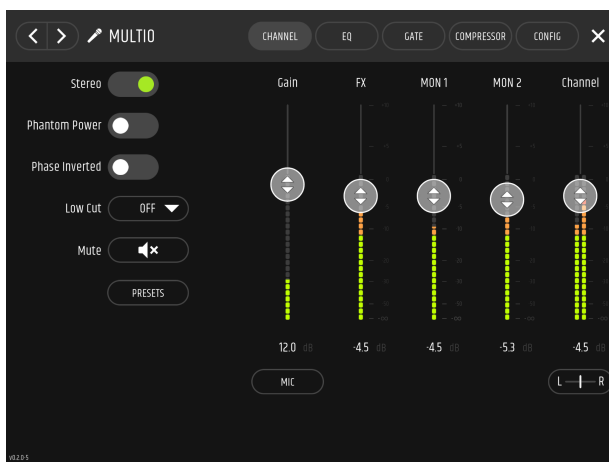

See also:

[Link to the Download Centre \[▶ 8\]](#)

7.3.3 UPDATING THE FIRMWARE

For full functionality of the device, update the firmware before commissioning. For instructions on updating the firmware, follow the QR code link to access the **MAUI® MIX** app user manual. Whenever a new firmware update is available, the **MAUI® MIX** app shows an indicator in the **SETTINGS** menu.



NOTICE

Do not switch off the device during the firmware update.

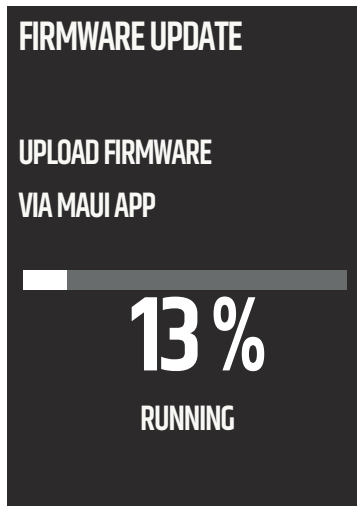

After the firmware update started, the **MAUI® G3 MIX** shows the **FIRMWARE UPDATE** screen. When the firmware update is complete, the **MAUI® G3 MIX** re-boots.

See also:

[Link to the Download Centre \[▶ 8\]](#)

[Pairing a Bluetooth® Low Energy \(BLE\) Device \[▶ 59\]](#)

[Fail-Safe Recovery Mode \[▶ 71\]](#)

[System Settings Overview \[▶ 52\]](#)

7.4 IDLE SCREEN OVERVIEW

After approximately 30 seconds of inactivity, the idle screen appears. You can replace the idle screen with a black screen saver in the display settings.

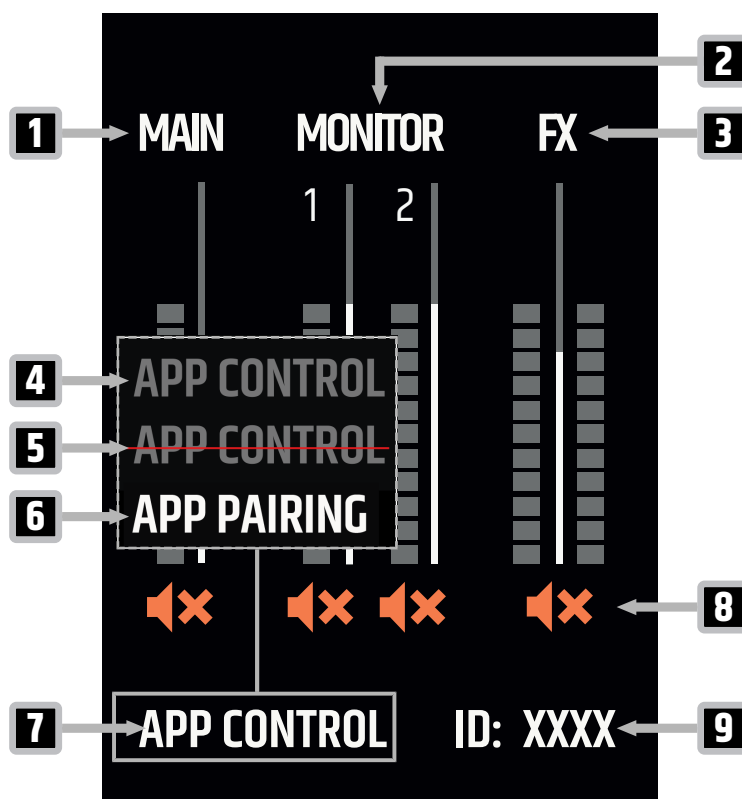

- 1 **MAIN metering** - Indicates the MONO or STEREO setting of the MAIN channel, the set level, and the signal.
- 2 **MONITOR metering** - Indicates the MONO or STEREO setting of the MONITOR OUT, the set level, and the signal.
- 3 **FX** - Indicates the set level of the effects and the FX return signal.
- 4 **APP CONTROL (BLE) not connected** - APP CONTROL is switched on in the settings and mobile device is not connected.
- 5 **APP CONTROL (BLE) not connected** - APP CONTROL is switched off in the settings.
- 6 **APP PAIRING (BLE) not connected** - APP PAIRING in progress. Select your MAUI® G3 MIX in the MAUI® MIX app.
- 7 **APP CONTROL (BLE) connected** - APP CONTROL is switched on in the settings and mobile device is connected.
- 8 **Mute Icons** - Indicates whether the corresponding channel is muted.
- 9 **ID number** - Indicates the ID of your MAUI® G3 MIX

See also:
 Display Settings Overview [▶ 51]
 App Access Overview [▶ 49]

7.5 EXPERT MODE OVERVIEWS

 Depending on the firmware version used, the user interface may differ in design and layout.

7.5.1 INPUT CHANNEL OVERVIEWS EXPERT MODE

7.5.1.1 INPUT METERING SECTION OVERVIEW EXPERT MODE

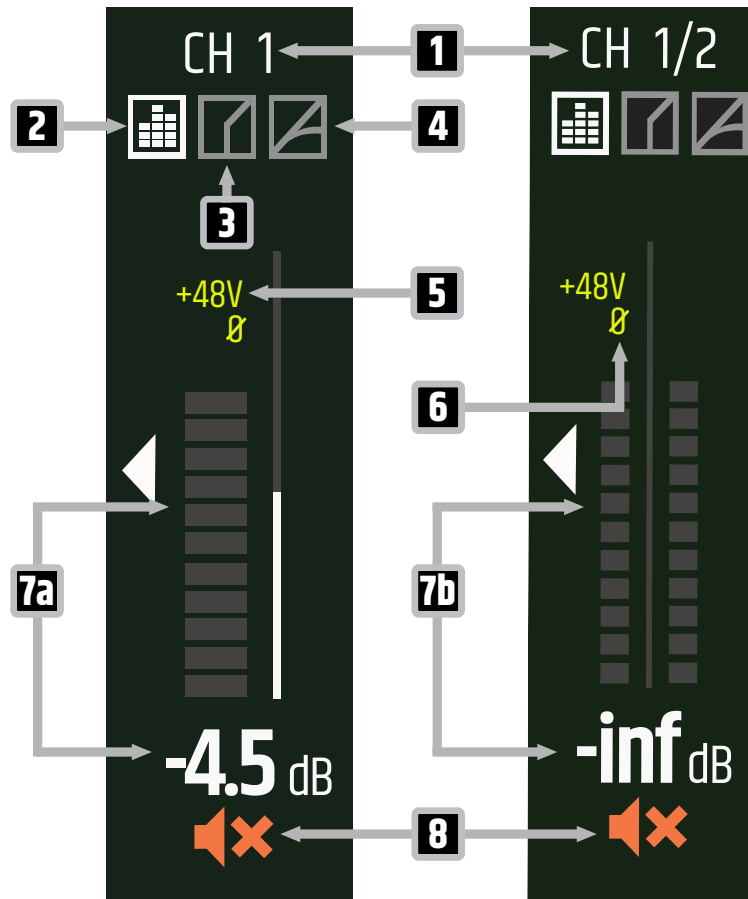

- 1 Channel Name** - Indicates the channel name in mono and stereo
- 2 Equaliser (EQ)** - When the icon is highlighted white, the EQ is active
- 3 Gate** - When the icon is highlighted white, the gate is active
- 4 Compressor** - When the icon is highlighted white, the compressor is active
- 5 +48V** - Indicates whether the phantom power is on
- 6 Ø** - Indicates whether the polarity is inverted
- 7a Metering Mono** - 11-segment metering and decibel value (-inf dB...+10 dB)
- 7b Metering Stereo** - 2x11-segment stereo metering and decibel value (-inf dB...+10 dB)
- 8 Mute** - Indicates whether the channel is muted. Push and hold the channel rotary-push encoder (RPE) to mute or unmute.

7.5.1.2

PREAMP SECTION OVERVIEW

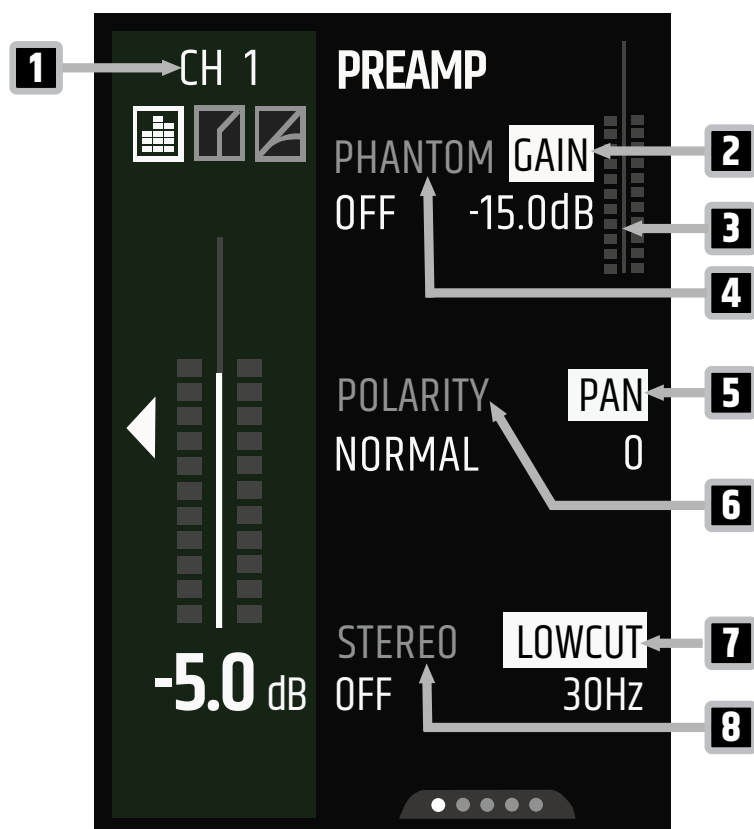

- 1 **Channel Name** - Indicates the input channel name
- 2 **GAIN** - Adjusts the preamp gain (CH 1, 2: -6 dB...+50 dB / CH. 3/4, BT: -6 dB...+36 dB)
- 3 **Gain Metering** - Indicates the gain level of the preamp
- 4 **PHANTOM** - Toggles 48V phantom power on or off
- 5 **PAN** - Adjusts the channel panorama in stereo mode (-100...+100)
- 6 **POLARITY** - Toggles the phase reverse of the input
- 7 **LOWCUT** - Adjusts the lowcut (OFF, 20 Hz...200 Hz)
- 8 **STEREO** - Toggles stereo or mono mode for channel 1. If stereo mode is on, channel 1 (L) and 2 (R) are linked.

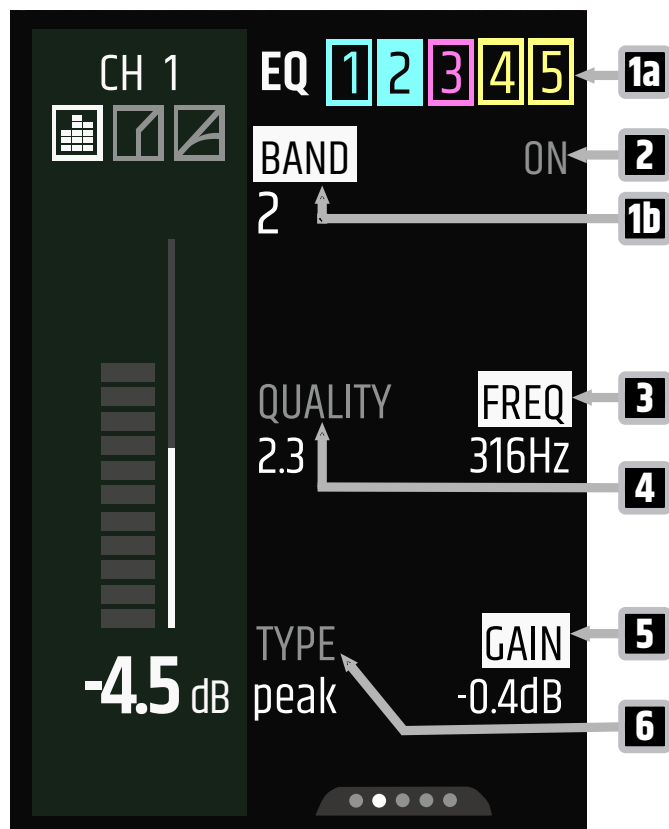

- 1a EQ 1-5** - Indicates the EQ band you select under 1b (1...5)
- 1b BAND** - Select the EQ band (1...5, ALL). Select ALL to switch the EQ on or off (see 2).
- 2 ON / OFF** - Toggles the EQ band 1 to 5 or the complete EQ (ALL) on or off.
- 3 FREQ** - Adjusts the frequency (20 Hz...20 kHz) of the selected EQ band (see 1b)
- 4 QUALITY** - Adjusts the slope of the selected frequency (0.5...10.0)
- 5 GAIN** - Adjusts the gain of the selected EQ band (+15 dB...-15 dB)
- 6 TYPE** - Adjusts the EQ type (peak, highshelf, lowshelf)

7.5.1.4

GATE SECTION OVERVIEW

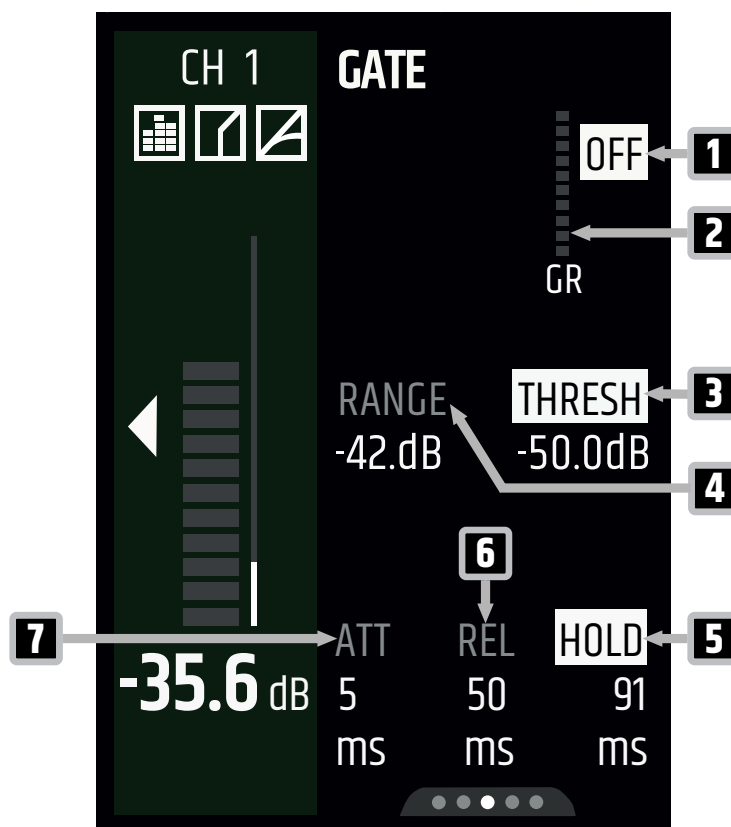

- 1 **ON / OFF** - Toggles the gate on or off
- 2 **GR** - Indicates the gain reduction of the gate
- 3 **THRESH** - Adjusts the gate threshold (-50 dB...0 dB)
- 4 **RANGE** - Adjusts the gate range (-90 dB...0 dB)
- 5 **HOLD** - Adjusts the gate hold time (1 ms...1000 ms)
- 6 **REL** - Adjusts the gate release time (1 ms...2000 ms)
- 7 **ATT** - Adjusts the gate attack time (1 ms...100 ms)

7.5.1.5 COMPRESSOR SECTION OVERVIEW

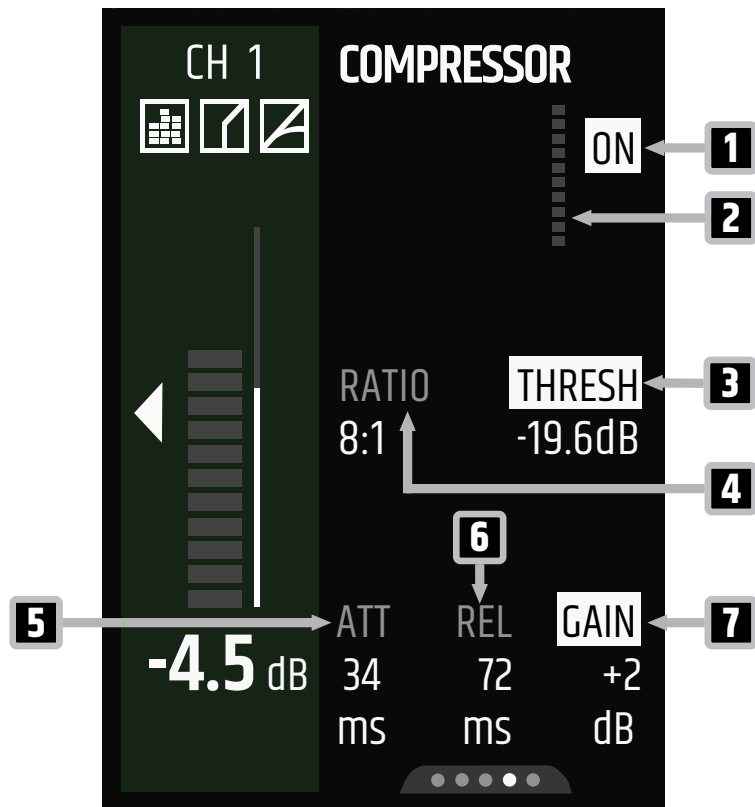

- 1 **ON / OFF** - Toggles the compressor on or off
- 2 **Gain Reduction** - Indicates the compressor gain reduction
- 3 **THRESH** - Adjusts the compressor threshold (-50 dB...0 dB)
- 4 **RATIO** - Adjusts the compressor ratio (1:1...20:1)
- 5 **ATT** - Adjusts the compressor attack time (1 ms...500 ms)
- 6 **REL** - Adjusts the compressor release time (1 ms...2000 ms)
- 7 **GAIN** - Adjusts the compressor make-up gain (0 dB...+20 dB)

7.5.1.6

SENDS SECTION OVERVIEW MONO

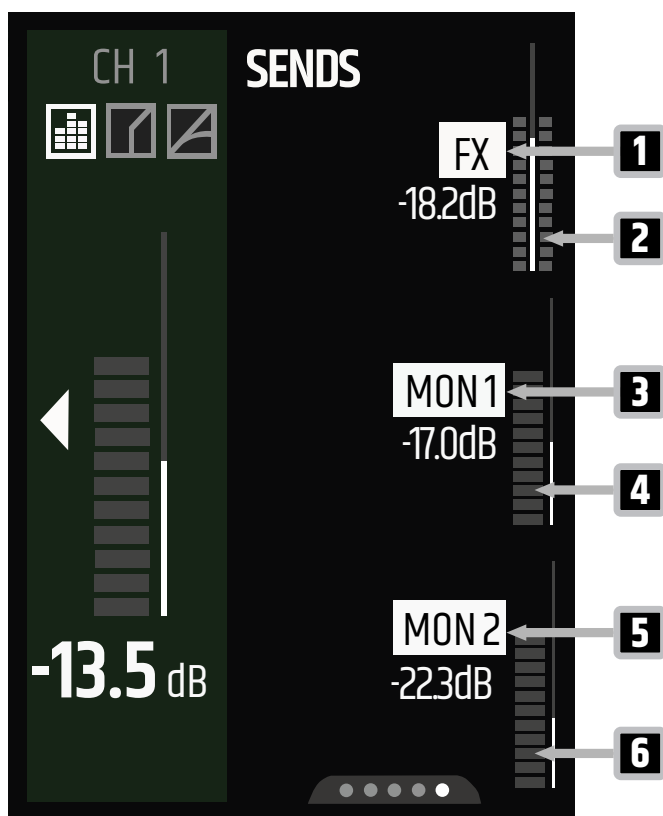

- 1 **FX** - Adjusts the send level from the selected input to the effects engine (-inf dB...+10 dB)
- 2 **Metering** - Indicates the signal going to the effects engine
- 3 **MON 1** - Adjusts the send level from the selected input to the MON 1 output (-inf dB...+10 dB)
- 4 **Metering** - Indicates the signal going to MON 1 output
- 5 **MON 2** - Adjusts the send level from the selected input to the MON 2 output (-inf dB...+10 dB)
- 6 **Metering** - Indicates the signal going to MON 2 output

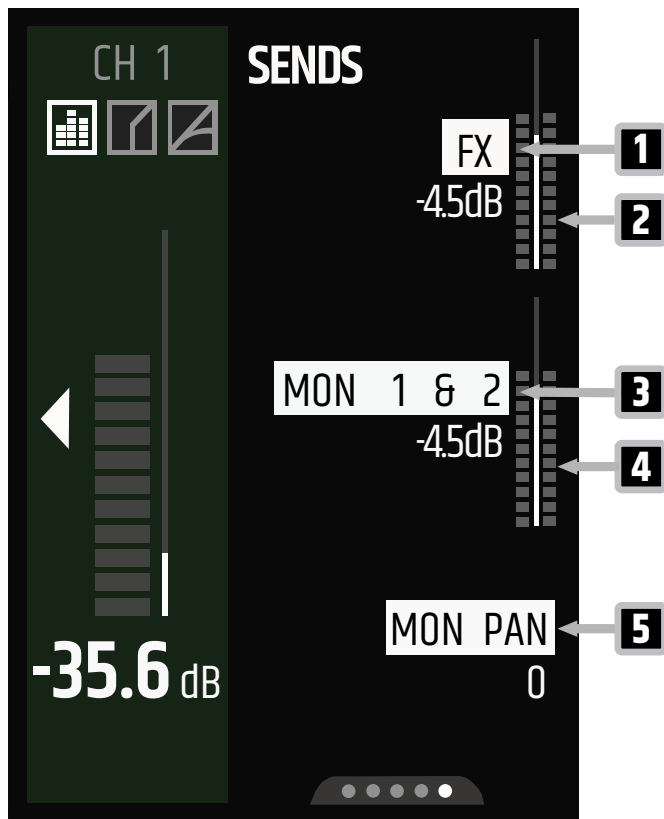

- 1 **FX** - Adjusts the send level from the selected input to the effects engine (-inf dB...+10 dB)
- 2 **Metering** - Indicates the signal going to the effects engine
- 3 **MON 1 & 2** - Adjusts the send level from the selected input to the monitor outputs (-inf dB...+10 dB)
- 4 **Metering** - Indicates the signal going to MON 1 & 2 outputs
- 5 **MON PAN** - Adjusts the monitor panorama (-100...100)

7.5.2 MAIN CHANNEL OVERVIEWS EXPERT MODE

7.5.2.1 MAIN METERING SECTION OVERVIEW

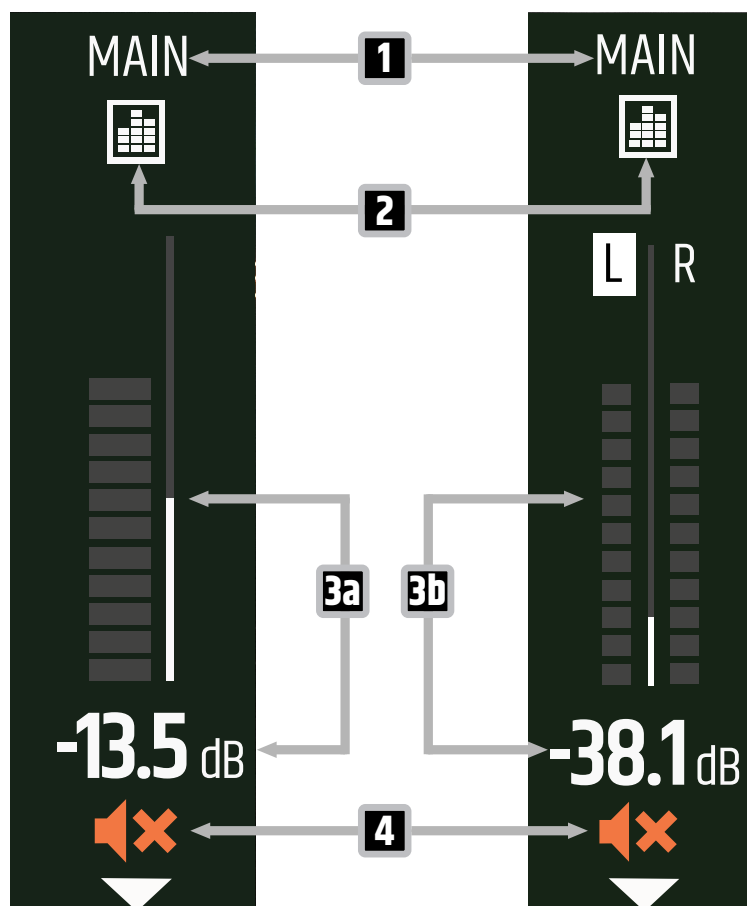

- 1 **Channel Name** - Indicates the main channel
- 2 **Equaliser (EQ)** - When the icon is highlighted white, the EQ is active
- 3a **Metering Mono** - 11-segment metering and decibel value (-inf dB...+10 dB)
- 3b **Metering Stereo** - 2x11-segment metering and decibel value (-inf dB...+10 dB)
- 4 **Mute** - Indicates whether the main channel is muted. Push and hold the rotary-push encoder (RPE) to mute or unmute.

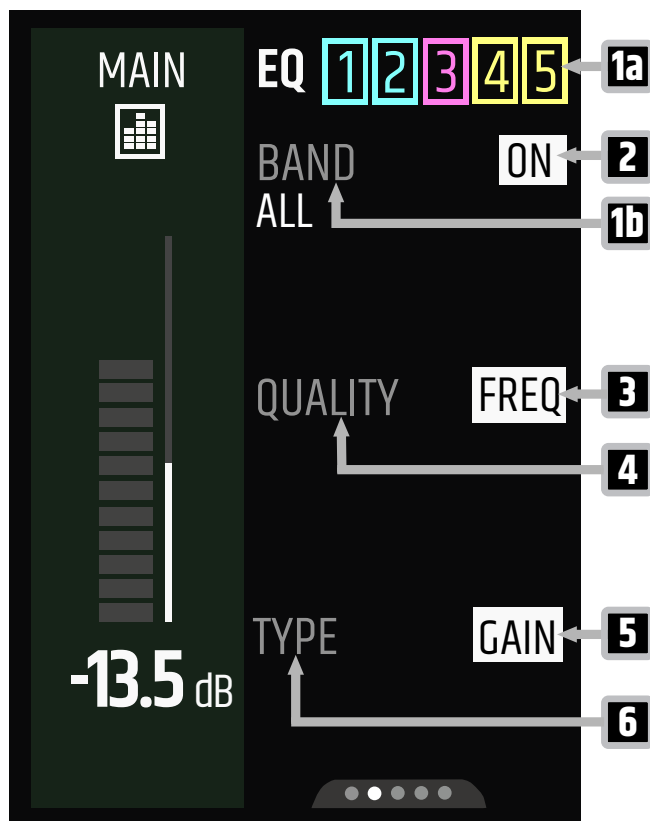

- 1a EQ 1-5** - Indicates the EQ band you select under 1b (1...5)
- 1b BAND** - Select the EQ band (1...5, ALL). Select ALL to switch the EQ on or off (see 2)
- 2 ON / OFF** - Toggles the EQ band 1 to 5 or the complete EQ (ALL) on or off
- 3 FREQ** - Adjusts the frequency (20 Hz...20 kHz) of the selected EQ band (see 1a)
- 4 QUALITY** - Adjusts the slope of the selected frequency (0.5...10.0)
- 5 GAIN** - Adjusts the gain of the selected EQ band (-15 dB... +15 dB)
- 6 TYPE** - Adjusts the EQ type (peak, highshelf, lowshelf)

7.5.2.3

MONITOR OUT SECTION MONO OVERVIEW

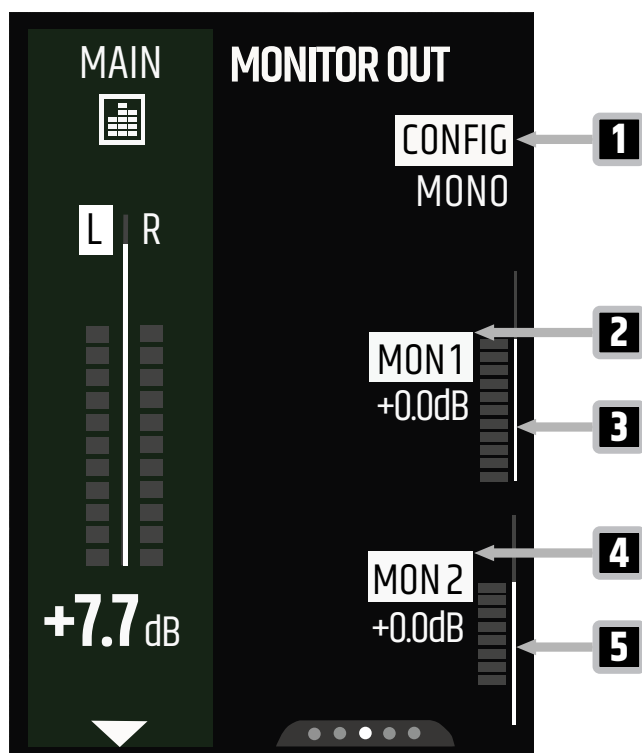

- 1 **CONFIG** - Toggles the MONITOR OUT mono or stereo
- 2 **MON1** - Adjusts the MON1 output level pre fader (-inf dB...+10 dB)
- 3 **Metering MON1** - Indicates the signal going to MON1 output
- 4 **MON2** - Adjusts the MON2 output level pre fader (-inf dB...+10 dB)
- 5 **Metering MON2** - Indicates the signal going to MON2 output

7.5.2.4 MONITOR OUT SECTION STEREO OVERVIEW

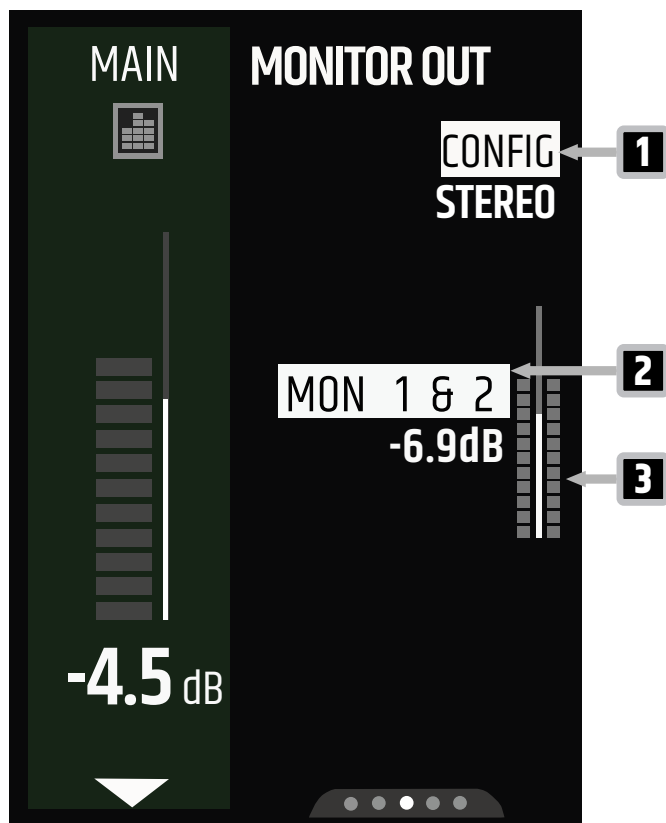

- 1 **CONFIG** - Toggles the MONITOR OUT mono or stereo
- 2 **MON 1 & 2** - Adjusts the MON 1 & 2 output level (-inf dB...+10 dB)
- 3 **Metering** - Indicates the signal going to MON 1 & 2 outputs

7.5.2.5 EFFECTS (FX)

The **MAUI® G3 Mix** has four built-in effects engines:

- Reverb
- Delay
- Chorus
- Combo

For detailed information about the effects, see the FX Section Overviews.

See also:

FX Section Overview Expert Mode [▶ 44]

FX Section Overview Easy Mode [▶ 57]

7.5.2.6

SYSTEM OUT SECTION OVERVIEW



The **SYSTEM OUT** page is not available in Easy Mode. The **SYSTEM OUT** on your **MAUI® G3 MIX** is fed with the post fade **SUB** signal.

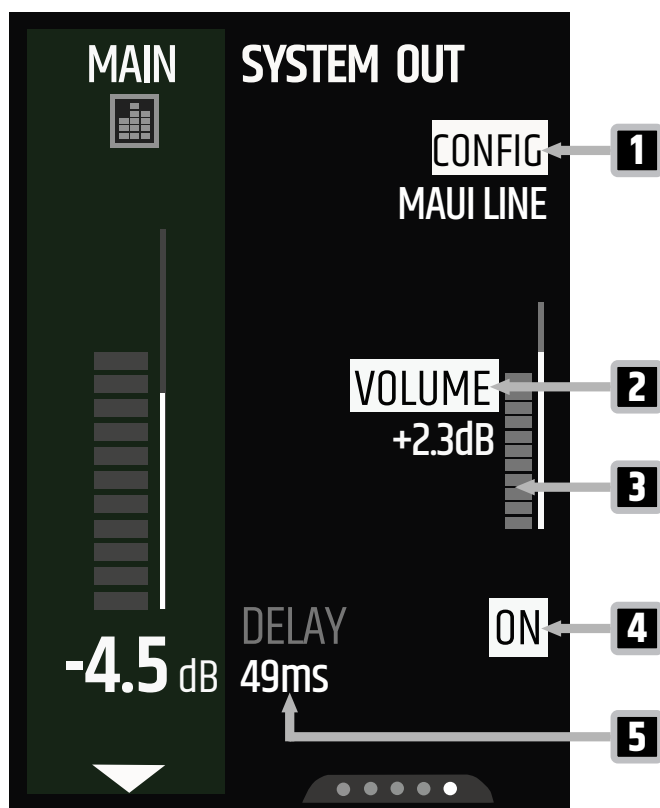

- 1 **CONFIG** - Sets the configuration* of the external device
- 2 **VOLUME** - Adjusts the volume of the SYSTEM OUT (-inf dB...+10 dB)
- 3 **Metering** - Indicates the signal going to the SYSTEM OUT
- 4 **ON / OFF** - Toggles the delay function on / off
- 5 **DELAY** - Adjusts the delay of the SYSTEM OUT (0 ms...100 ms)

*MAUI LINE, MAUI LINE SUB, LEFT (POST), RIGHT (POST), MONO (POST), SUB, LEFT (PRE), RIGHT (PRE), MONO (PRE)

7.5.3 FX SECTION OVERVIEW EXPERT MODE

7.5.3.1 FX REVERB OVERVIEW

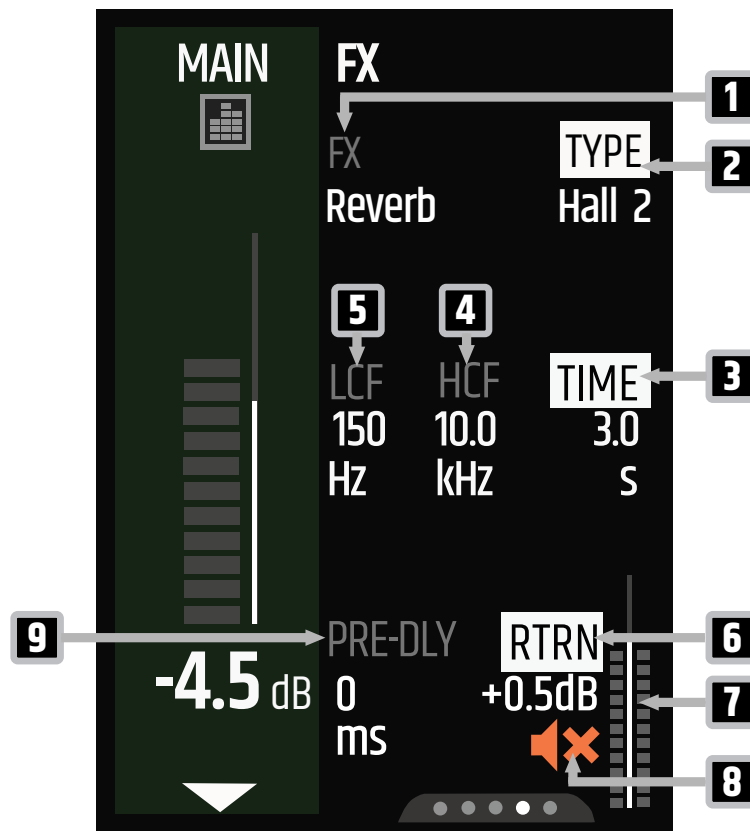

- 1 **FX** - Sets the effect category (Reverb, Delay, Chorus, Combo). Most effect categories have different type options (see 2).
- 2 **TYPE** - Sets the reverb type (Room, Plate, Hall 1, Hall 2, Space)
- 3 **TIME** - Adjusts the reverberation time (0.7 s...4 s)
- 4 **HCF** - Adjusts the highcut filter of the effect (5 kHz...20 kHz)
- 5 **LCF** - Adjusts the lowcut filter of the effect (0 Hz...400 Hz)
- 6 **RTRN** - Adjusts the effect return level (-inf dB...+10 dB)
- 7 **Return Metering** - Indicates the effect return level
- 8 **Mute** - Indicates whether the effect return is muted. Push and hold the lower display rotary-push encoder (RPE) to mute or unmute.
- 9 **PRE-DLY** - Adjusts the pre-delay time (0 ms...150 ms)

7.5.3.2

FX DELAY OVERVIEW

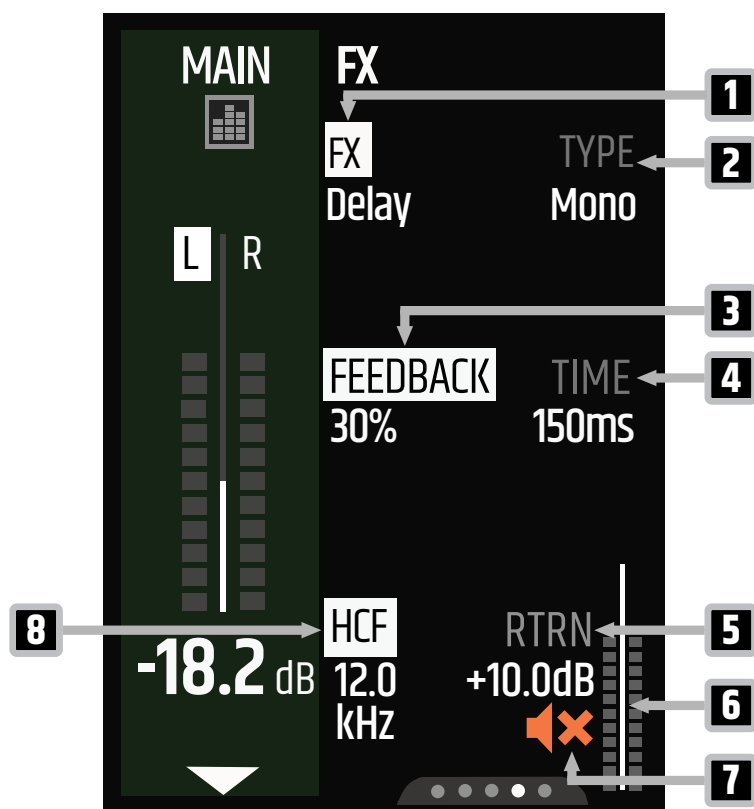

- 1 **FX** - Sets the effect category (Reverb, Delay, Chorus, Combo). Most effect categories have different type options (see 2).
- 2 **TYPE** - Sets the delay type (Mono, PingPong, Galaxy)
- 3 **FEEDBACK** - Adjusts the feedback percentage (0 %...80 %)
- 4 **TIME** - Adjusts the delay time (30 ms...1000 ms)
- 5 **RTRN** - Adjusts the effect return level (-inf dB...+10 dB)
- 6 **Return Metering** - Indicates the effect return level
- 7 **Mute** - Indicates whether the effect return is muted. Push and hold the display rotary-push encoder (RPE) to mute or unmute.
- 8 **HCF** - Adjusts the high cut filter of the effect (2.0 kHz...20 kHz)

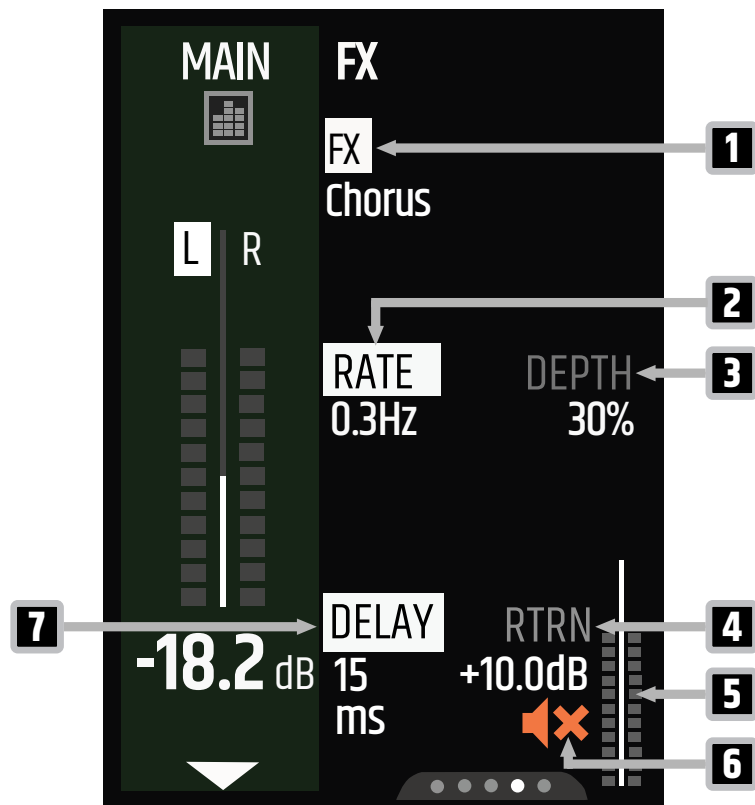

- 1 **FX** - Sets the effect category (Reverb, Delay, Chorus, Combo).
- 2 **RATE** - Adjusts the chorus rate (0.1 Hz...10 Hz)
- 3 **DEPTH** - Adjusts the chorus depth percentage (0 %...100 %)
- 4 **RTRN** - Adjusts the effect return level (-inf dB...+10 dB)
- 5 **Return Metering** - Indicates the effect return level
- 6 **Mute** - Indicates whether the effect return is muted. Push and hold the display rotary-push encoder (RPE) to mute or unmute.
- 7 **DELAY** - Adjusts the delay time (5 ms...100 ms)

7.5.3.4

FX COMBO OVERVIEW

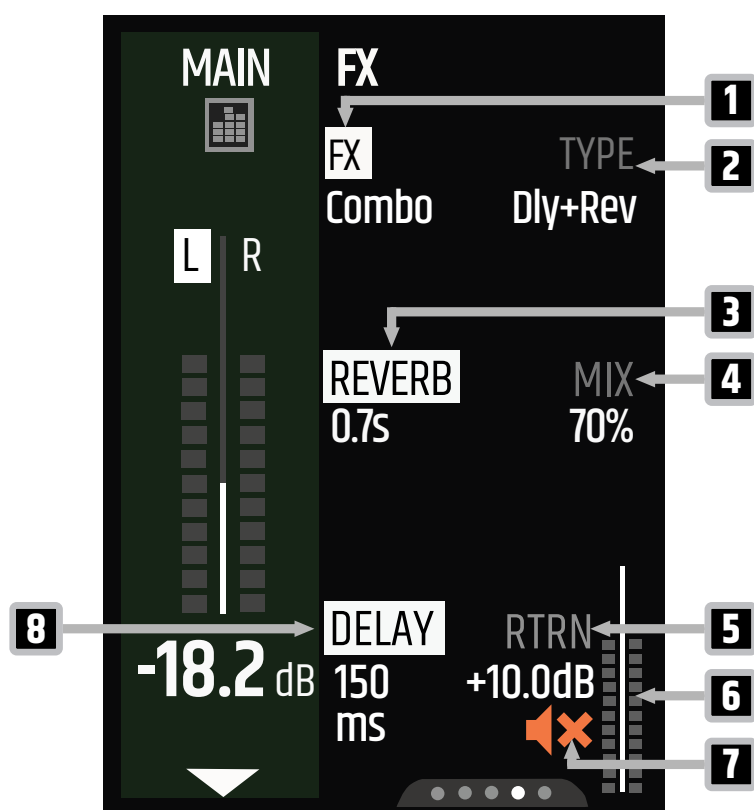

- 1 **FX** - Sets the effect category (Reverb, Delay, Chorus, Combo). Most effect categories have different type options (see 2).
- 2 **TYPE** - Indicates the effect type (Dly+Rev)
- 3 **REVERB** - Adjusts the reverberation time (0.7 s...4.0 s)
- 4 **MIX** - Adjusts the mix of the effect (0 %...100 %)
- 5 **RTRN** - Adjusts the effect return level (-inf dB...+10 dB)
- 6 **Return Metering** - Indicates the effect return level
- 7 **Mute** - Indicates whether the effect return is muted. Push and hold the display rotary-push encoder (RPE) to mute or unmute.
- 8 **DELAY** - Adjusts the delay time (30 ms...1000 ms)

7.5.4 SETTINGS SECTION OVERVIEW EXPERT MODE

7.5.4.1 GLOBAL SETTINGS OVERVIEW

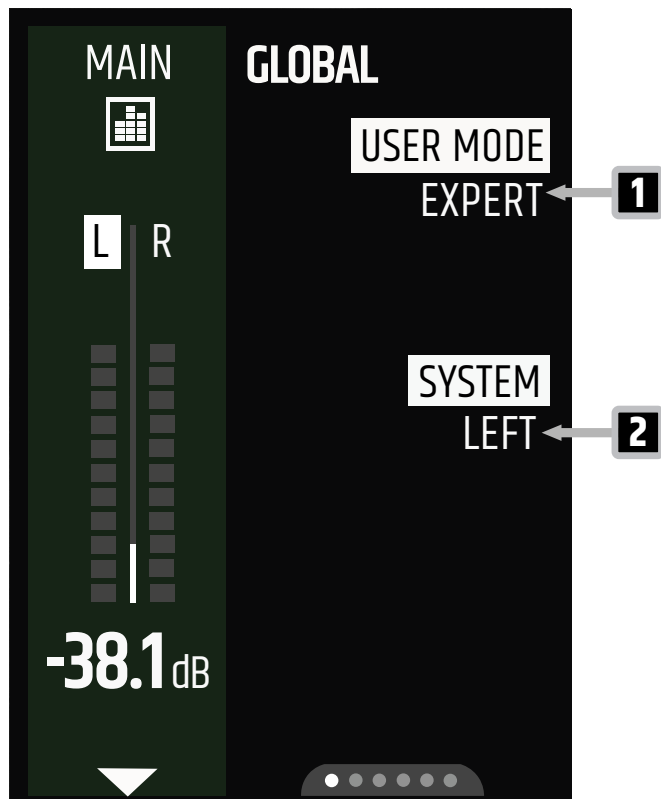

- 1 USER MODE** - Toggles the user mode (EXPERT, EASY)
- 2 SYSTEM** - Sets the MAUI® MIX to single-device-mode (MONO) or to stereo mode (LEFT, RIGHT) for SysLink® connections.

7.5.4.2

APP ACCESS OVERVIEW

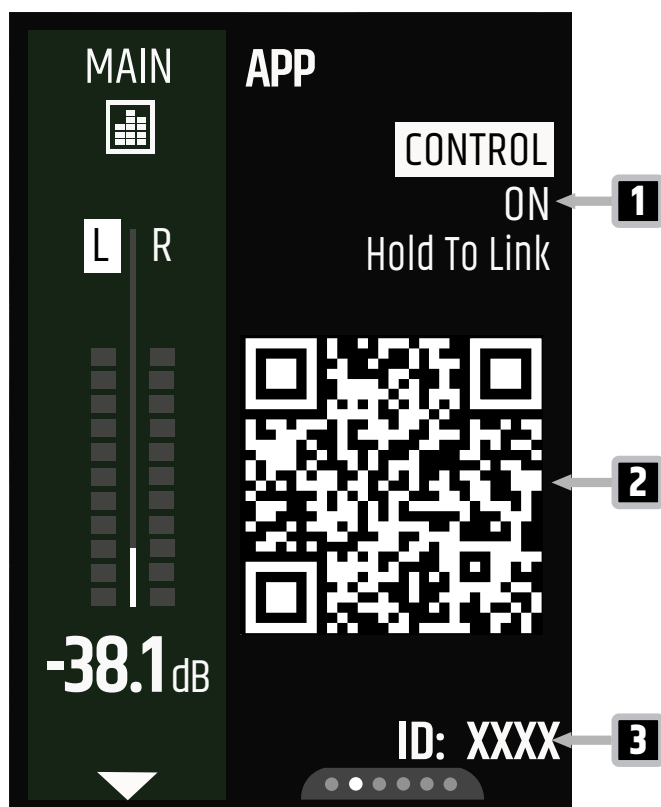

- 1 CONTROL** - Toggles the app remote connection on / off. Push and hold the upper display rotary-push encoder (RPE) to start PAIRING. When connected to the app, the display switches to CONNECTED.
- 2 QR Code** - Scan the QR code to download the latest MAUI® MIX app version.
- 3 ID number** - Indicates the ID of your MAUI® G3 MIX

7.5.4.3

FOOTSWITCH SETTINGS OVERVIEW



Use a 2-button footswitch for the MAUI® G3 MIX.

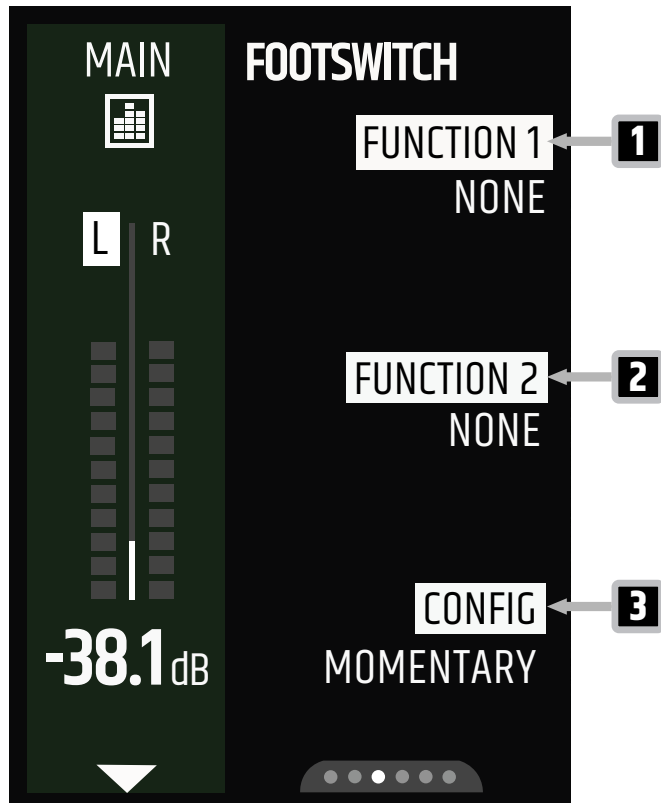

- 1 FUNCTION 1** - Selects the footswitch function 1 (NONE, MAIN MUTE, FX ON/OFF)
- 2 FUNCTION 2** - Selects the footswitch function 2 (NONE, MAIN MUTE, FX ON/OFF)
- 3 CONFIG** - Toggles the footswitch to switch mode (LATCHING) or push-and-hold mode (MOMENTARY).

See also:
Using the Footswitch [▶ 61]

7.5.4.4

DISPLAY SETTINGS OVERVIEW

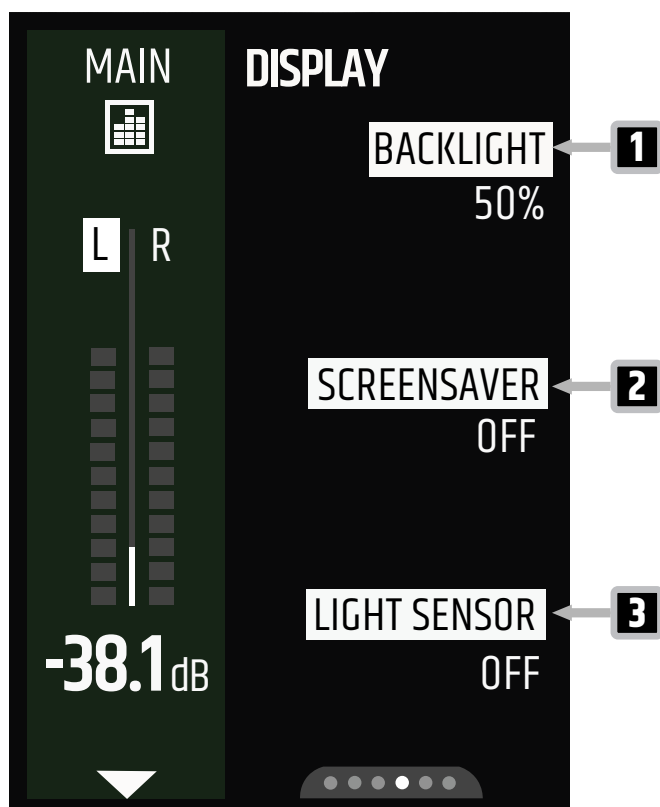

- 1 BACKLIGHT** - Adjusts the backlight intensity (10 %...100 %, AUTO)
- 2 SCREENSAVER** - Toggles the screensaver ON / OFF
- 3 LIGHT SENSOR** - Toggles the light sensor ON / OFF. When you select OFF, BACKLIGHT (see 1) changes to AUTO.

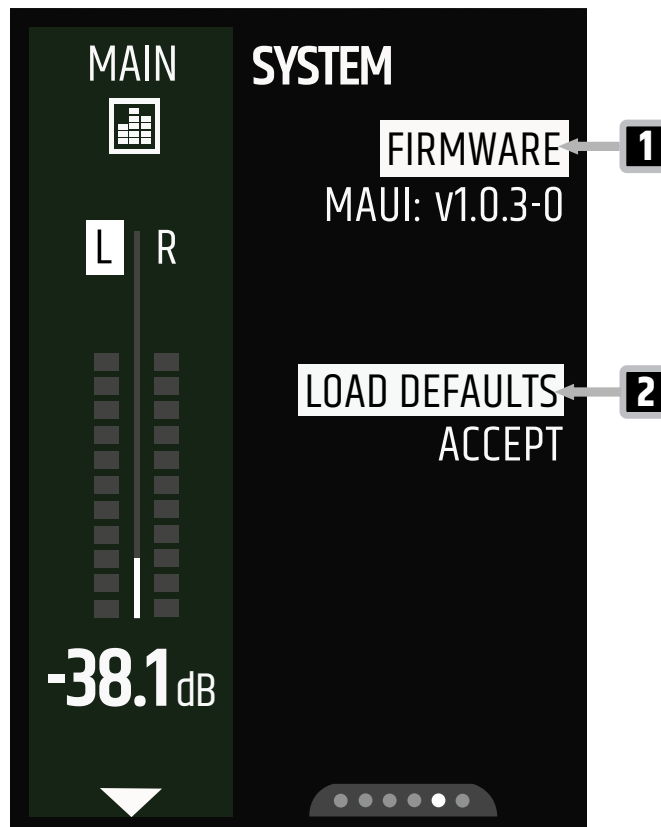

- 1 **FIRMWARE** - Selects the firmware version indicators (MAUI, CORE, UI, DSP, PREAMP)
- 2 **LOAD DEFAULTS** - Select to reset the device to default settings.

See also:
Resetting the Device to Default Settings [▶ 70]

7.5.4.6

AMP SECTION OVERVIEW

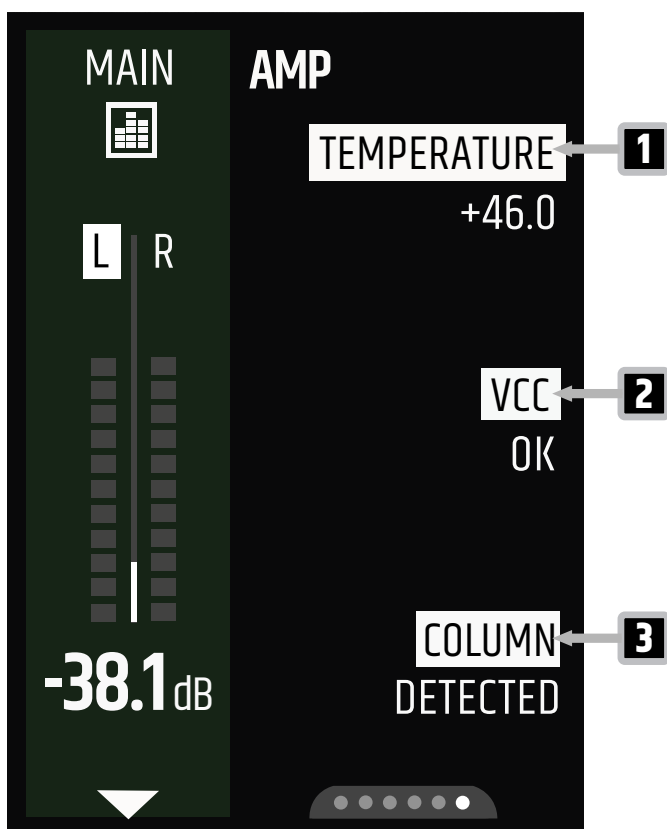

- 1 **TEMPERATURE** - Indicates the amplifier temperature in °C
- 2 **VCC** - The Voltage Common Collector (VCC) indicates if the main voltage is in the required range for operation.
- 3 **COLUMN** - Indicates whether the upper and lower array columns are connected correctly (DETECTED, NOT DETECTED)

See also:
Component Overview [▶ 22]

7.6

EASY MODE OVERVIEWS



Depending on the firmware version used, the user interface may differ in design and layout.

See also:
GLOBAL Settings Overview [▶ 48]

7.6.1 INPUT CHANNEL OVERVIEWS EASY MODE



In Easy Mode, EQ, COMPRESSOR, and GATE are active per default and do not have an on or off switch.

7.6.1.1 EQ SECTION OVERVIEW EASY MODE

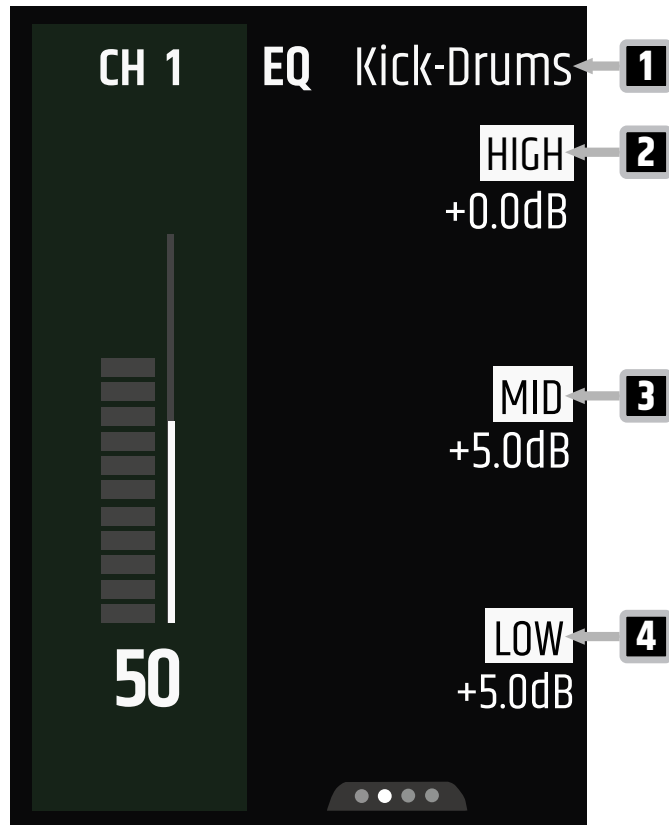

- 1 Preset** - Indicates the selected preset
- 2 HIGH** - Adjusts the high band of the EQ (-15 dB...+10 dB)
- 3 MID** - Adjusts the mid band of the EQ (-15 dB...+10 dB)
- 4 LOW** - Adjusts the low band of the EQ (-15 dB...+10 dB)

7.6.1.2

CONFIG OVERVIEW EASY MODE

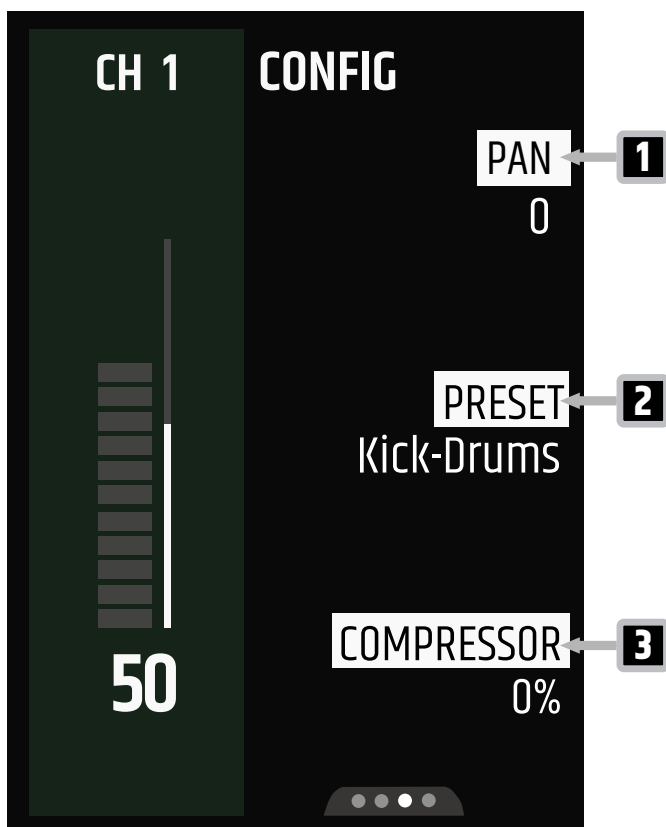

- 1 **PAN** - Adjusts the channel panorama (-100...100)
- 2 **PRESET** - Sets the preset for EQ* and COMPRESSOR*
- 3 **COMPRESSOR** - Adjusts the amount of compression (0 %...100 %)

**Default, E-Bass, Vocal-Male, Vocal-Female, Kick-Drums, Snare, Acoustic-Guitar, E-Guitar, Keys*

See also:
Presets [▶ 61]

7.6.2 MAIN CHANNEL OVERVIEWS EASY MODE

7.6.2.1 MAIN EQ SECTION OVERVIEW EASY MODE

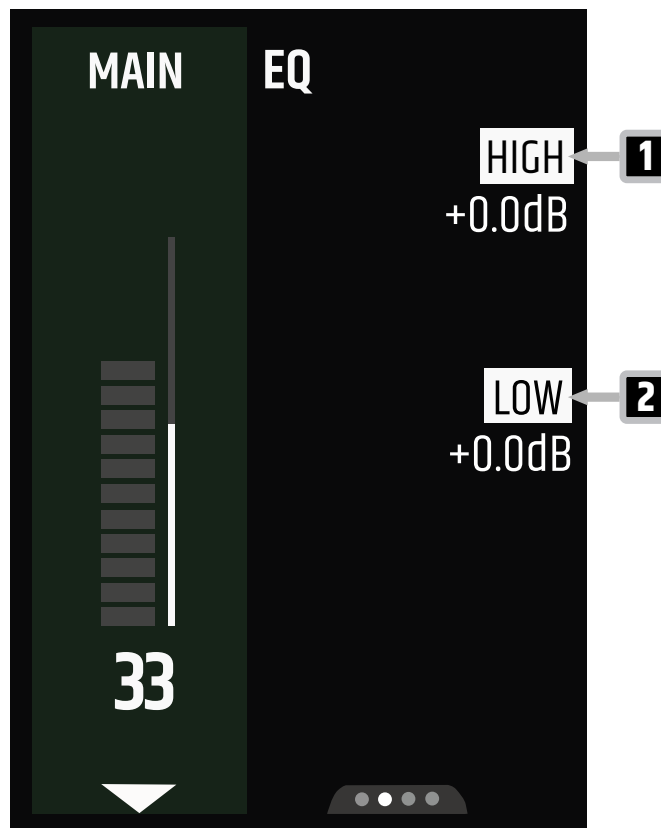

- 1 HIGH** - Adjusts the high band of the EQ (-15 dB...+5 dB)
- 2 LOW** - Adjusts the low band of the EQ (-15 dB...+5 dB)

7.6.2.2

FX SECTION OVERVIEW EASY MODE

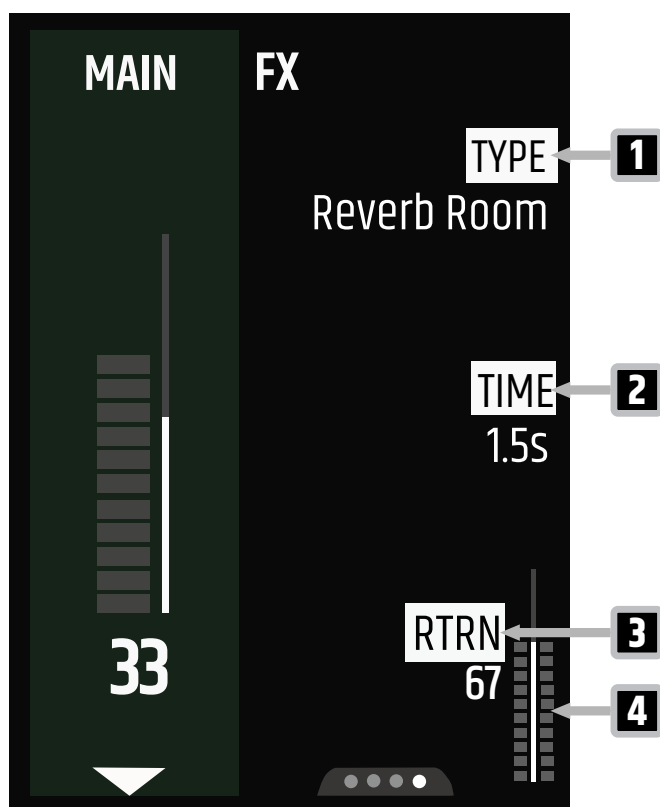

- 1 **TYPE** - Sets the FX type (see table "Effect Settings")
- 2 **TIME / DEPTH / MIX** - Adjusts the FX parameter value
- 3 **RTRN** - Adjusts the effect return level (0...100)
- 4 **Return Metering** - Indicates the effect return level

EFFECT SETTINGS

TYPE	FX Parameter	Value Range
Reverb Room	TIME	0.3 s...2.0 s
Reverb Place	TIME	0.7 s...4.0 s
Reverb Hall 1	TIME	0.7 s...4.0 s
Reverb Space	TIME	0.7 s...4.0 s
Delay Mono	TIME	30 ms...1000 ms
Delay PingPong	TIME	30 ms...1000 ms
Delay Galaxy	TIME	30 ms...1000 ms
Chorus	DEPTH	0 %...100 %
Combo Dly+Rev	MIX	0...50

7.7 INPUT CONNECTIONS

7.7.1 CONNECTING AN INPUT SOURCE TO THE MIC / LINE / HI-Z INPUT



CAUTION

High sound pressure levels

Risk of hearing damage

- a. Make sure that the main volume is turned all the way down, before you connect any input sources.



NOTICE

High Sound Pressure Level

Damage to the loudspeaker

- a. Connect line level devices, such as mixing consoles, to the line input only.

- 1 Set the input to **MIC**, **LINE**, or **HI-Z**.
 - a) Push the **SELECT** button until the corresponding input type lights up.
- 2 Connect a **MIC**, **LINE**, or **HI-Z** input source to **INPUT 1** or **INPUT 2**.

7.7.2 BLUETOOTH®

7.7.2.1 ABOUT BLUETOOTH® AND BLUETOOTH® LOW ENERGY (BLE)

The **MAUI® G3 MIX** series features two wireless connection standards:

- Bluetooth® for wireless audio streaming
- Bluetooth® Low Energy (BLE) for transmission of control signals between the **MAUI® MIX** app and the **MAUI® G3 MIX**

7.7.2.2 PAIRING A DEVICE VIA BLUETOOTH® FOR AUDIO PLAYBACK

- ✓ You have a Bluetooth®-ready mobile device, such as a smartphone or tablet.

- 1 Turn on Bluetooth® on your mobile device.
- 2 On the **MAUI® G3 MIX**, push and hold the **HOLD TO LINK** button for 2 seconds to start the pairing process.
 - ⇒ The ✦ LED above the **HOLD TO LINK** button starts to flash.
- 3 Follow the procedure for Bluetooth® pairing on your mobile device.
 - ⇒ The ✦ LED above the **HOLD TO LINK** button lights up permanently.
 - ⇒ Your mobile device is paired and ready for audio playback.



When you use the **MAUI® G3 MIX** in SysLink® mode, you can pair two Bluetooth®-ready devices, one to each **MAUI® G3 MIX**. As a result, both Bluetooth®-ready devices can play back audio simultaneously.



If your **MAUI® G3 MIX** is already paired via Bluetooth®, it will not appear in the Bluetooth® menu of other mobile devices. Unpair the currently paired mobile device to make the **MAUI® G3 MIX** available for other devices.

7.7.2.3 UNPAIRING A BLUETOOTH® AUDIO PLAYBACK DEVICE

✓ You have a Bluetooth® device paired to your **MAUI® G3 MIX**.

- 1 Push and hold the **HOLD TO LINK** button for 2 seconds.

⇒ Your mobile device is unpaired from the **MAUI® G3 MIX**.

7.7.2.4 PAIRING A BLUETOOTH® LOW ENERGY (BLE) DEVICE

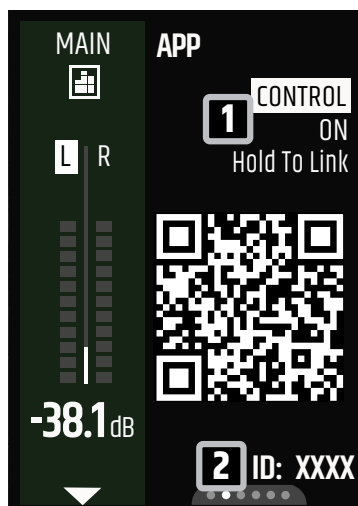

✓ You have a Bluetooth®- and BLE-ready mobile device, such as a smartphone or tablet. The BLE version of your device must be 4.2 or higher, version 5.0 is recommended.

- 1 Turn on Bluetooth® on your mobile device.
- 2 Push and hold the upper display **rotary-push encoder (RPE)** until **PAIRING** appears. **1**
- 3 Open the **MAUI® MIX** app on your mobile device and connect your **MAUI® G3 MIX** system.
 - a) Use the **ID 2** to identify your device.

 Find further information on using the app in the download centre.

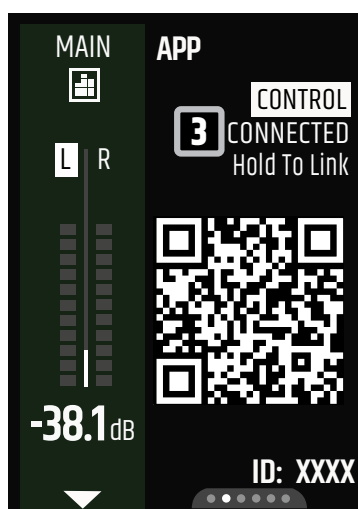

- 4 The display shows **CONNECTED**. **3**

⇒ Your mobile device is paired and ready for remote control.

 Only one **PAIRING** connection is possible at a time. The **PAIRING** process overwrites existing connections.

See also:

About Bluetooth® and Bluetooth® Low Energy (BLE) [▶ 58]

Link to the Download Centre [▶ 8]

7.8 AUDIO PLAYBACK

7.8.1 ADJUSTING THE PREAMP GAIN

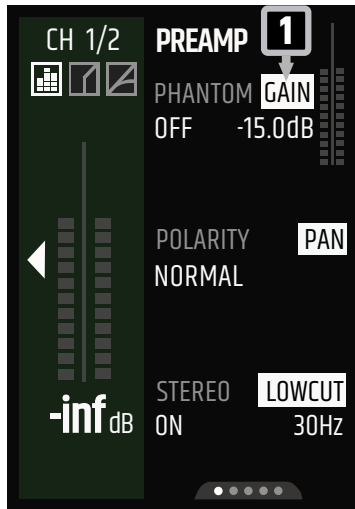

- 1 Push the channel **rotary-push encoder (RPE)** of any input channel.
- 2 Use the **PAGE** button to navigate to the **PREAMP** page.
- 3 Push the upper display **RPE** until **GAIN** is highlighted. **1**
- 4 Turn the upper display **RPE** to adjust the gain.

7.8.2 ADJUSTING THE CHANNEL VOLUME

- 1 Turn the channel **rotary-push encoder (RPE)** clockwise to increase the channel volume.
- 2 Turn the channel **RPE** anticlockwise to decrease it.



The channel **RPE** LED ring displays the current volume level. See the exact decibel value on the display. Push the channel **RPE** to show the selected channel in the display.

7.8.3 ADJUSTING THE MAIN VOLUME

- 1 Turn the **MAIN rotary-push encoder (RPE)** clockwise to increase the main volume.
- 2 Turn the **MAIN RPE** anticlockwise to decrease it.



The **MAIN RPE** LED ring displays the current volume level. See the exact decibel value on the display. Push the **MAIN RPE** to show the main channel in the display.

7.8.4 USING THE FOOTSWITCH

- 1 Connect the jack of your footswitch to the **FOOTSWITCH** socket.
- 2 Set up your footswitch configuration:
 - a) Push the **MAIN rotary-push encoder (RPE)** to access the main channel.
 - b) Push the **PAGE** button to browse to the **FOOTSWITCH** page.
 - c) Turn the upper display **RPE** to set **FUNCTION 1**. Turn the mid display **RPE** to set **FUNCTION 2**.
 - d) Turn the lower display **RPE** to set the footswitch **CONFIG** to **MOMENTARY** or **LATCHING**.



You can configure 3 footswitch functions (**NONE** (no function), **MAIN MUTE, FX ON / OFF**).



If you want to use footswitch **FUNCTION 2**, use a 2-button footswitch.

See also:

Footswitch Settings Overview [▶ 50]

7.8.5 PRESETS

For quick and easy adjustments find pre-configured channel presets in **EASY MODE**, such as **E-Bass**, **Vocal-Male**, or **Kick-Drums**. These pre-configured presets contain typical settings for the respective sound sources. For advanced preset functionality in **EXPERT MODE** download the **MAUI® MIX** app.

See also:

Downloading the Mobile App [▶ 28]

7.9 OUTPUT CONNECTIONS

7.9.1 SYSLINK®

7.9.1.1 CONNECTING A MAUI® SYSTEM VIA SYSLINK®

 For **SysLink®** connections use only RJ45 cables with a maximum length of 30 metres. We recommend using the **Adam Hall Cables 4 STAR ECON CAT6A 10m**. You find this cable under the article number **K4CAT6100** in our webshop at <https://www.adamhall.com/shop>

✓ You need a second **MAUI® G3 MIX** system.

- 1 Turn on both **MAUI® G3 MIX** systems.
- 2 Connect the **SysLink®** port of both devices using a CAT cable.
 - ⇒ The **REMOTE** LED of both devices starts flashing orange.
 - ⇒ The **SYSLINK** screen appears on both devices.

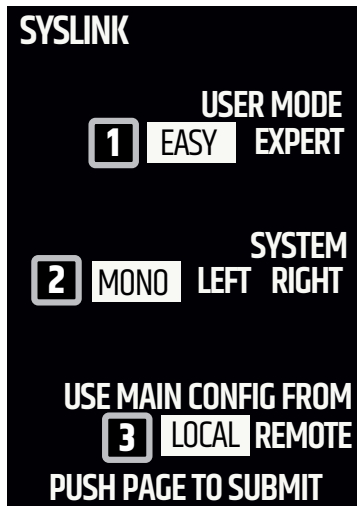

If the **USER MODE** of the devices are configured differently, the **USER MODE** setting option appears.

- 3 Turn the upper display **rotary-push encoder (RPE)** to choose **EASY** mode or **EXPERT** mode.
 - 1

If the **SYSTEM** setting option of the devices are configured differently, the **SYSTEM** setting option appears.

- 4 Turn the middle display **RPE** to choose **MONO**, **LEFT** or **RIGHT**.
 - 2

Use the main config from the **LOCAL** or the **REMOTE** device. The device on which you make the selection, is the **LOCAL** device.

 - 3
- 5 Turn the lower display **RPE** to choose **LOCAL** or **REMOTE**.

 The **MAIN CONFIG** contains all settings, such as volume levels or EQ settings. Using the **MAIN CONFIG** of one device overwrites the settings of the other.

- 6 Push the **PAGE** button to submit.
 - ⇒ The **REMOTE** LED of both devices lights up.
 - ⇒ The **SysLink®** connection is active.

7.9.1.2

RESETTING SYSLINK® DEVICES TO DEFAULT SETTINGS

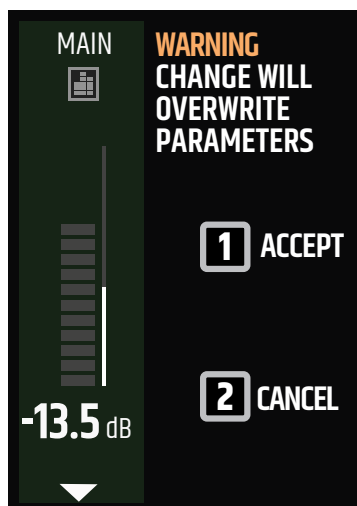

✓ You have connected a second MAUI® G3 MIX via SysLink®.

- 1 Press and hold the **PAGE** button to access the system settings.
 - ⇒ The warning message **WARNING: CHANGE WILL OVERWRITE PARAMETERS** opens.
- 2 Press the middle display **rotary-push encoder (RPE)** to **ACCEPT** **1** or the lower display **RPE** to **CANCEL** **2**.
 - ⇒ The **GLOBAL** settings open.



CAUTION

Sudden Volume Changes

Risk of hearing damage

Damage to the loudspeaker

- a. Make sure no audio signal devices are connected.

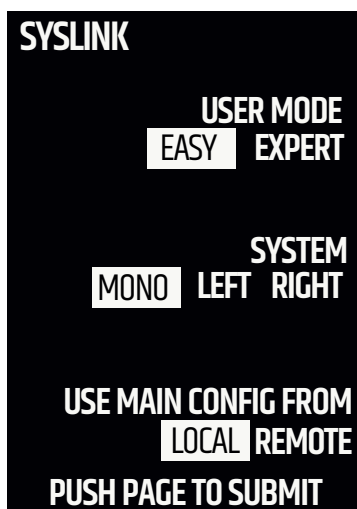
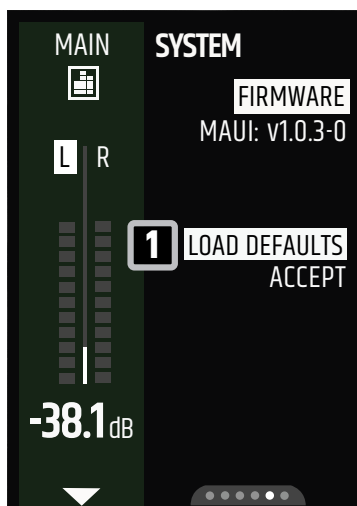

- 3 Push the **PAGE** button until the **SYSTEM** page shows up.
- 4 Turn the middle display **RPE** to **LOAD DEFAULTS** **1**.
 - ⇒ If **LEFT**, **RIGHT** or **MONO** on each system is configured differently, the **SYSLINK** screen appears on both devices.
- 5 Turn the middle display **RPE** to choose **MONO**, **LEFT** or **RIGHT**.
- 6 Turn the lower display **RPE** to choose **LOCAL** or **REMOTE**.
- 7 Push the **PAGE** button to submit.

7.9.1.3 SETTING LEFT (L) AND RIGHT (R) ON A MAUI SYSTEM CONNECTED VIA SYSLINK®



Per default settings, the device is configured as **MONO**.

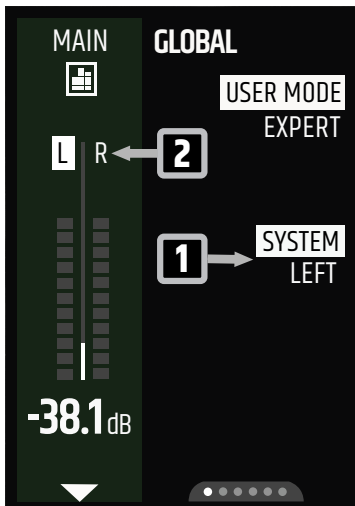
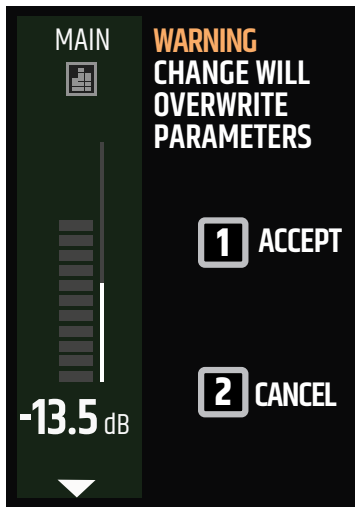

✓ You have connected a second **MAUI G3 MIX** via **SysLink®**.

- 1 Press and hold the **PAGE** button to access the system settings.
 - ⇒ The warning message **WARNING: CHANGE WILL OVERWRITE PARAMETERS** opens.
- 2 Press the middle display **rotary-push encoder (RPE)** to **ACCEPT 1** or the lower display **RPE** to **CANCEL 2**.
- 3 Turn the middle display **RPE** to choose **LEFT** or **RIGHT. 1**
 - ⇒ In the **MAIN** metering section on the left, **L** or **R** is highlighted accordingly. **2**

See also:

Connecting a MAUI® System via SysLink® [▶ 62]

7.9.1.4 REMOTE-CONTROLLING A SYSLINK® DEVICE

✓ You have two **MAUI® G3 MIX** systems connected via **SysLink®**.

- 1 On the **LOCAL** device, push the **REMOTE** button.
 - ⇒ The LED rings, the **REMOTE** LED, and the display edges of the **LOCAL** device light up orange.
 - ⇒ You can now control the **REMOTE** device via the **LOCAL** device.
- 2 Push the **REMOTE** button again to cancel remote control.

7.9.2 SYSTEM OUT

7.9.2.1 SYSTEM OUT USE CASES

STEREO CARDIOID CONFIGURATION WITH 2 MAUI® G3 MIX SYSTEMS AND 2 MAUI® G3 SUBWOOFERS

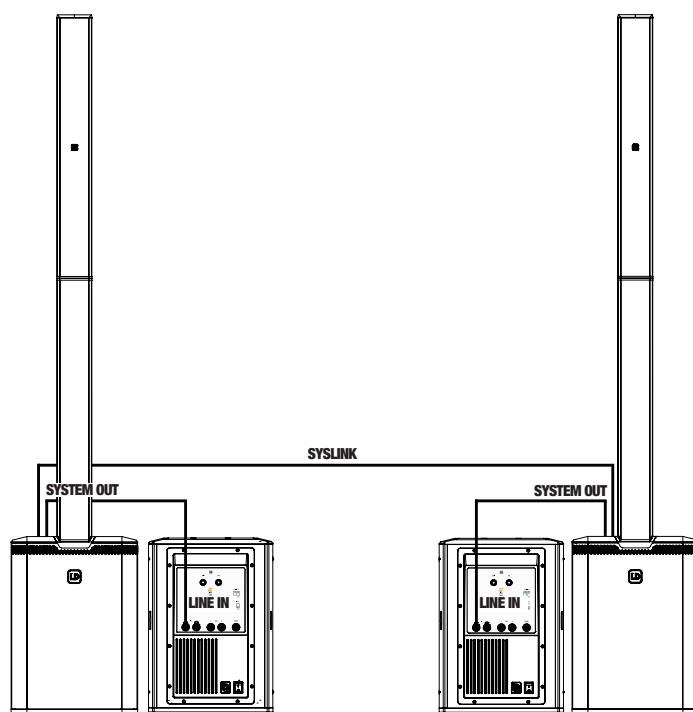

STEREO CONFIGURATION WITH 2 MAUI® G3 MIX SYSTEMS AND 2 MONITORS

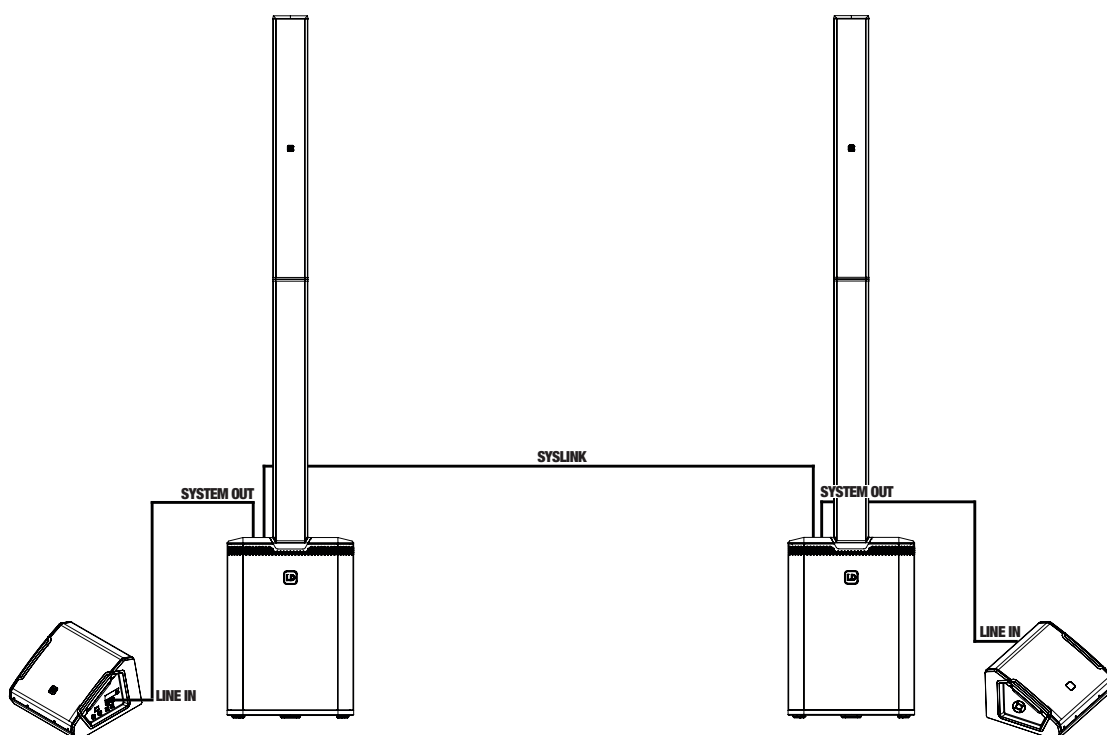

STEREO CONFIGURATION WITH 2 MAUI® G3 MIX SYSTEMS AND 1 ADDITIONAL MONO SYSTEM IN EXPERT MODE

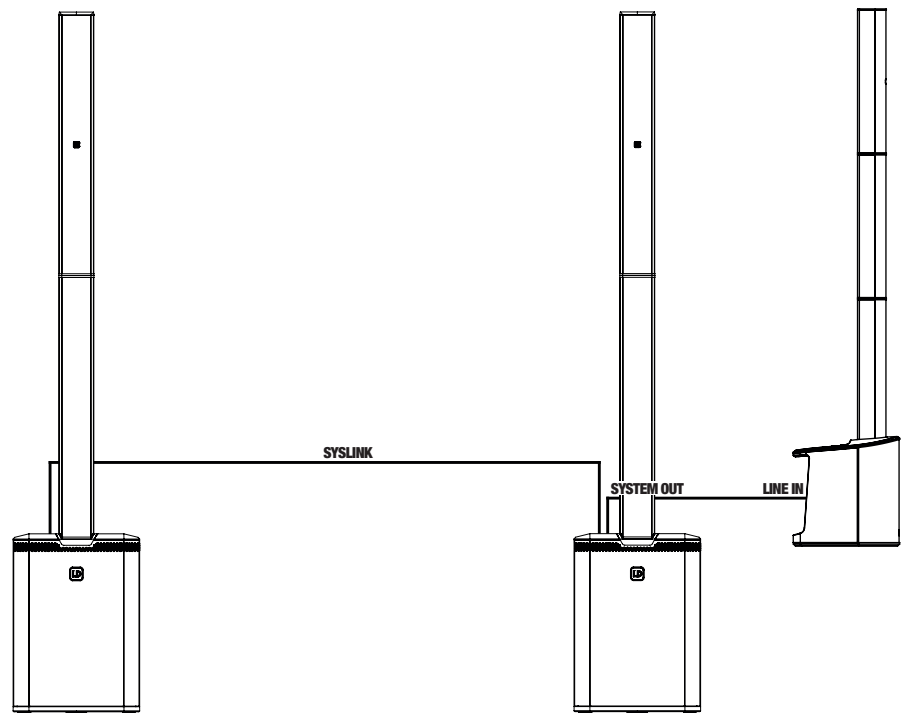

See also:
Using the System Out [▶ 67]

7.9.2.2

USING THE SYSTEM OUT

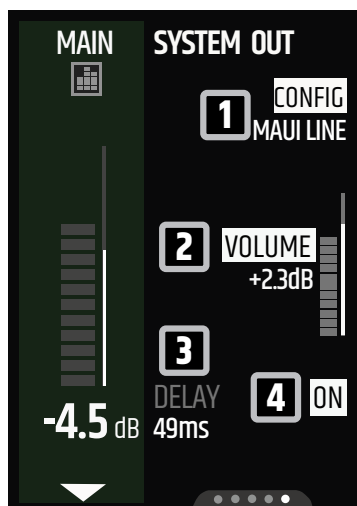

✓ You have connected a line input of an external device to the **SYSTEM OUT** of the **MAUI® G3 MIX** via XLR cable.

- 1** Turn the upper display **rotary-push encoder (RPE)** to choose the **CONFIG 1** that fits the configuration of the external device, such as **SUB, LEFT / RIGHT (POST / PRE)**, or **MONO (POST / PRE)**.
- 2** Turn the middle display **RPE** to adjust the volume of the **SYSTEM OUT**. **2**
- 3** If necessary, use the output delay of the **SYSTEM OUT**:
 - a) Push the lower display **RPE** until **DELAY** is highlighted. **3**
 - b) Turn the lower **RPE** to adjust the delay time for the **SYSTEM OUT**.



You can toggle the delay function **ON / OFF 4**. Per default the delay function is **ON**.

See also:
System Out Use Cases [▶ 65]

8 | MAINTENANCE

8.1 CLEANING THE DEVICE



CAUTION

Mains Voltage

Risk of electric shock

- a. Before you perform maintenance work on the device, disconnect the device from all poles.



NOTICE

Damage to the device and void of warranty

- a. Perform maintenance on the device on a regular basis.
- b. Do not use cleaning agents, disinfectants, alcohol, or agents with abrasive effect for cleaning.

Carry out the maintenance measures listed below every 500 hours of operation. In case of less intensive use, perform maintenance work after 1 year at the latest.

- Clean the housing surface with a clean and damp cotton cloth. Wipe off all excess moisture to prevent damage to the internals.
- Clean any air inlets and outlets of dust and dirt. If you use compressed air, make sure that all fans are blocked to prevent damage to the internals.
- Clean all plug contacts from dust and dirt with a dry cotton cloth.

8.2 STORING THE DEVICE

Store the device only in a dry and clean environment. If you are storing the individual components of the device, use special protective covers, bags, and cases. Find such accessories for your product in the Adam Hall Shop (<https://www.adamhall.com/shop>).

See also:
Optional Accessories [▶ 16]

8.3 TROUBLESHOOTING

Problem	Cause	Solution
Bluetooth® connection interrupted or disturbed	Distance between device and MAUI® MIX too large	Reduce distance between device and MAUI® MIX
	Pairing issues	<ul style="list-style-type: none"> • Switch Bluetooth® off and on again on mobile device • Reboot mobile device and the MAUI® MIX
SysLink® connection cannot be established	Different software versions on both MAUI® G3 Mix	Remove SysLink® cable from at least one MAUI® MIX system and restart both MAUI® MIX systems
SysLink® connection not working	<ul style="list-style-type: none"> • CAT cable is defective • CAT cable is too long 	For SysLink® connections use only RJ45 cables with a maximum length of 30 metres
MAUI® MIX app connection not working	Distance between device and MAUI® MIX too large	Reduce distance between device and MAUI® MIX
Error during the firmware update	Interrupted connection during firmware update process	Start FAIL-SAFE RECOVERY mode
Input signal distorted	<ul style="list-style-type: none"> • Input gain set too high • Input signal distorted before being fed to the MAUI® MIX (e.g. broken audio playback device) 	<ul style="list-style-type: none"> • Reduce channel gain of corresponding input • Check the quality of the input signal
Main limiter is active (LIMIT LED illuminated continuously)	Main volume is too loud	Turn main rotary-push encoder (RPE) anticlockwise to decrease volume

See also:

Fail-Safe Recovery Mode [▶ 71]

Adjusting the PREAMP Gain [▶ 60]

8.4 RESETTING THE DEVICE TO DEFAULT SETTINGS



NOTICE

Resetting the device will overwrite parameters.



If you have connected a second MAUI® G3 MIX via SysLink®, see [Resetting SysLink® Devices to Default Settings](#).

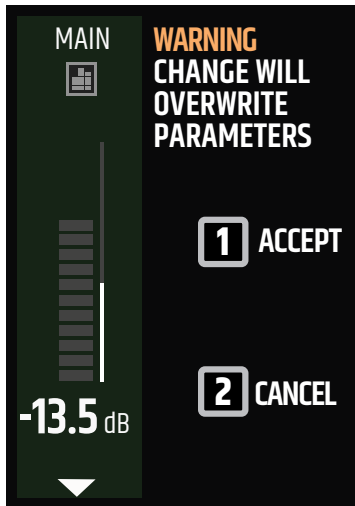

- 1 Push and hold the **PAGE** button to access the system settings.
⇒ The warning message **WARNING: CHANGE WILL OVERWRITE PARAMETERS** opens.
- 2 Push the middle display **rotary-push encoder (RPE)** to **ACCEPT 1** or the lower display **RPE** to **CANCEL 2**.
⇒ The **GLOBAL** settings open.



CAUTION

Sudden Volume Changes

Risk of hearing damage

Damage to the loudspeaker

- a. Make sure no audio signal devices are connected.

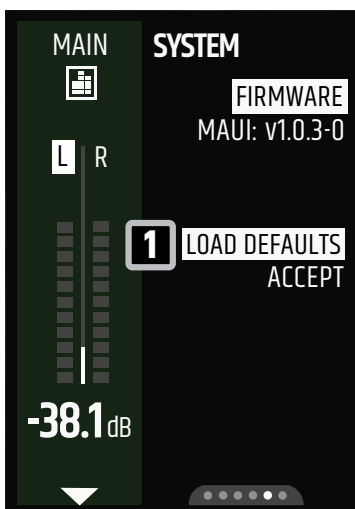

- 3 Push the **PAGE** button until the **SYSTEM** page shows up.
- 4 Turn the middle display **RPE** to **LOAD DEFAULTS 1**.

See also:

System Settings Overview [▶ 52]

Resetting SysLink® Devices to Default Settings [▶ 63]

8.5 FAIL-SAFE RECOVERY MODE

If a firmware update does not run properly, start the **MAUI® G3 MIX** in fail-safe recovery mode.

8.5.1 STARTING THE DEVICE IN FAIL-SAFE RECOVERY MODE

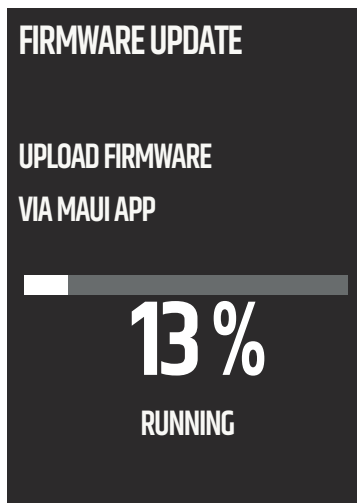

✓ The **MAUI® G3 MIX** is switched off.

- 1** Push and hold the **MAIN rotary-push encoder (RPE)**.
- 2** Turn on the **MAUI® G3 MIX**.
⇒ The screen displays **ENTERING FAIL-SAFE RECOVERY**.
- 3** Release the **MAIN RPE**.
⇒ The **MAUI® G3 MIX** is in Fail-Safe Recovery mode.
- 4** Use the **MAUI® G3 MIX** app to upload the firmware.

See also:
Updating the Firmware [▶ 30]

9 | REPAIR



CAUTION

Do not repair the device.

- a. Repairs may only be carried out by specialist personnel authorised by the manufacturer.
 - b. If your device is damaged or requires service, contact the Adam Hall Customer Service.
-

See also:
Contacts [▶ 8]

10 | DISPOSAL

10.1 PACKAGING DISPOSAL



1. You can feed the packaging into the reusable material cycle using the usual disposal methods.
2. Separate the packaging in accordance with the applicable disposal laws and recycling regulations in your country

10.2 DEVICE DISPOSAL



1. This device is subject to the European Directive on Waste Electrical and Electronic Equipment, as amended. WEEE Directive Waste Electrical and Electronic Equipment. Old appliances do not belong in the household waste. The old device must be disposed of via an approved disposal company or a municipal disposal facility. Observe the applicable regulations in your country.
2. Observe all disposal laws applicable in your country.
3. As a private customer, you can obtain information on environmentally friendly disposal options from the seller of the product or the appropriate regional authorities.

INDEX

A

Accessories	16
App	28, 29, 30

B

Bluetooth®	58, 59
Bluetooth® Low Energy (BLE)	58, 59

C

Cleaning	68
Customer Service	8

D

Default settings	70
Dimensions	17
Display rotary-push encoder	27

E

Easy Mode	21, 53
Expert Mode	21, 32

F

Factory reset	70
Firmware	30
Footswitch	61

H

HI-Z	58
------	----

I

Idle screen	31
-------------	----

L

LINE	58
------	----

M

Mains power cable	22, 25
MIC	58

P

Page button	28
Preamp gain	60

S

Storage	68
SysLink®	62, 63, 64
System Out	65, 67

V

Volume	
Channel volume	60
Main volume	60

