

MAILA[®]

MODULAR ALL-ROUND INTELLIGENT LINE ARRAY

LDsystems [®]
your sound. our mission.

your sound.
our mission.



SOUND
TECHNOLOGY

LIGHT
TECHNOLOGY

STAGE
EQUIPMENT

HARDWARE
FOR FLIGHTCASES

LD Systems® is a registered brand of the Adam Hall Group.



LD SYSTEMS – YOUR SOUND. OUR MISSION.

As a user, you are in good hands with LD Systems. Your enthusiasm is our benchmark. Whether you are an event technician, system integrator, mobile DJ or musician - your needs are at the heart of every decision we make. We are passionate about developing professional audio solutions that make your life easier on the job and meet your high expectations for sound and performance.

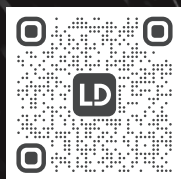

BOOK A DEMO
ld-systems.com/maila-demo

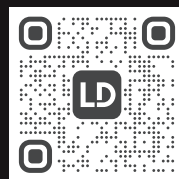

VIEW ONLINE
ld-systems.com/maila

SOME JOBS REQUIRE
A **BIG** LINE ARRAY.

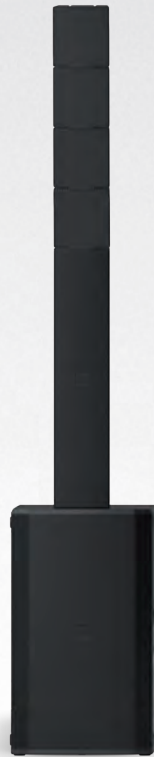

FOR EVERYTHING ELSE,
THERE IS MAILA.[®]



THE FOUR MAILA® MODULES

MAILA (Modular All-Round Intelligent Line Array) is not just “one” product, but a scalable sound reinforcement system that sets new standards in its diversity and flexibility. From a wedding reception to a conference to a festival - MAILA combines the best concepts of sound reinforcement technology in one system. Also, with the EasySplay® mechanism and many other clever features, MAILA takes user-friendliness in the line array sector to a whole new level. The result is a big, scalable sound for almost any application.



MAILA® SAT

PASSIVE ARRAY SATELLITE SPEAKER

Frequency response (6 dB):	100 Hz - 20 kHz
Power rating:	-
Max. SPL Peak (Pink noise):	129.1 dB (fullspace @1m, Crest factor 4)
Connectivity:	SmartLink+®
Weight:	7.65 kg
Dimensions (W x H x D):	205 x 234 x 226 mm



MAILA® SPA

AMPLIFIER FOR UP TO EIGHT SATELLITES

Frequency response (-6 dB):	-
Amplifying power:	1.25 kW RMS
Connectivity:	SmartLink+®, XLR, LogoLink®
Weight:	7.45 kg
Dimensions (W x H x D):	205 x 282 x 226 mm



MAILA[®] COL

POWERED 4 X 6.5" COLUMN SPEAKER AND AMPLIFIER

Frequency response (-6 dB):	105 Hz - 500 Hz
Amping power:	2.5 kW RMS
Max. SPL Peak (Pink noise)	130 dB (fullspace @1m, Crest factor 4)
Connectivity:	SmartLink+ [®] , XLR, LogoLink [®]
Weight:	36.195 kg
Dimensions (W x H x D):	205 x 1028 x 354 mm



MAILA[®] SUB

POWERED DUAL 15" BANDPASS SUBWOOFER

Frequency response (-6 dB):	33 Hz - Preset
Amping power:	2.5 kW RMS
Max. SPL Peak (Pink noise)	131 dB (fullspace @1m, Crest factor 4)
Connectivity:	XLR, LogoLink [®]
Weight:	89.8 kg
Dimensions (W x H x D):	540 x 934 x 803 mm

FULL FLEXIBILITY OF CONFIGURATION

With MAILA you enjoy a new sound reinforcement concept with full flexibility of configuration. The column and the satellite power amplifier allow for ground stack, pole mount and flown setups with up to 8 satellites that always precisely match your application. MAILA is a groundbreaking system for professional live sound applications, clubs and large halls. With its slim, cable-free design concept, it is also perfect for theatres.

No need to commit to one system only.

MAILA has many faces.

GROUND STACKING - UP TO 6 SATELLITES

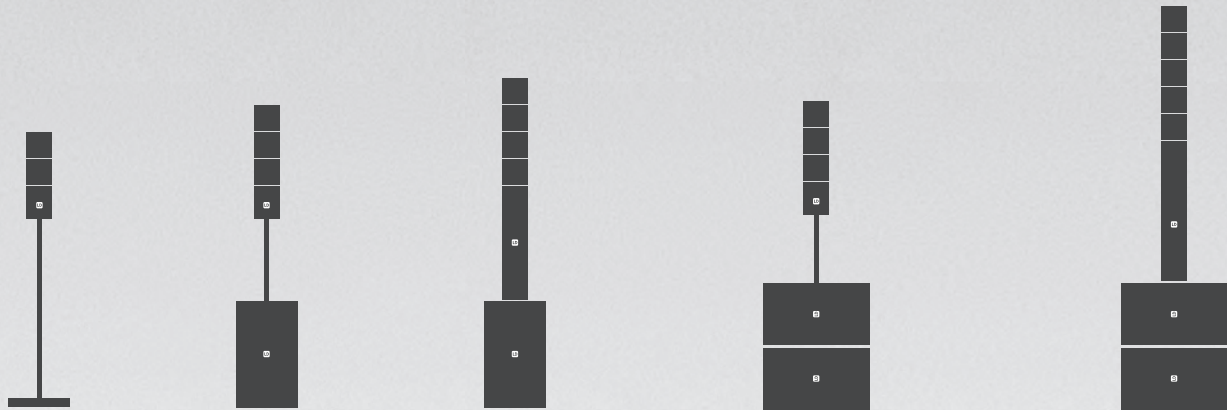

FLOWN SETUPS - UP TO 8 SATELLITES

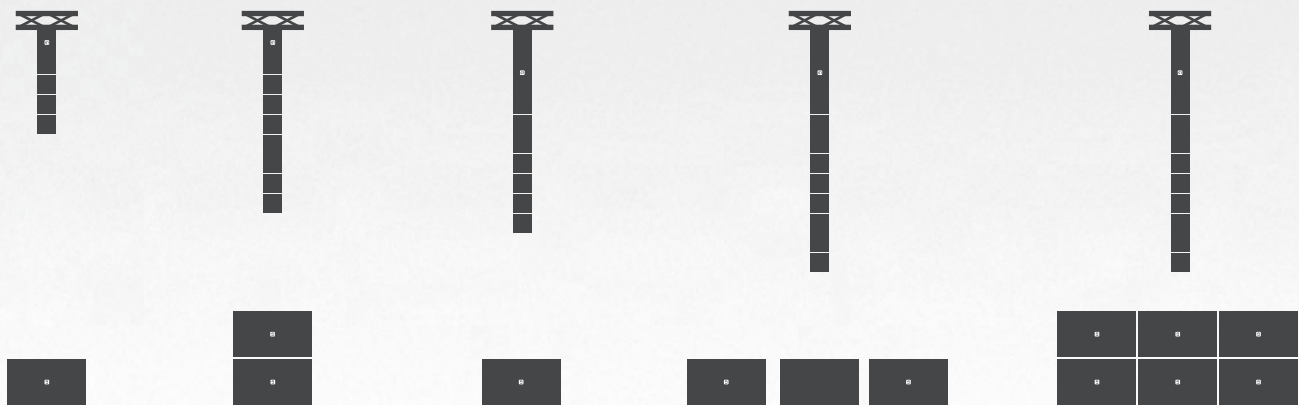

MAILA® S

Even in the SMALL configuration, the smallest MAILA system is an extremely powerful, active full-range stereo system. The ground stack system consists of one MAILA SUB 2 x 15" high-performance subwoofer, three MAILA SAT satellites and one MAILA SPA amplifier module driving the satellites, per stereo side.

Like the larger MAILA configurations, MAILA S combines a variety of acoustic concepts to bring maximum power and sound quality from an exceptionally compact and versatile PA system.

The result is a classic line array dispersion with impressive throw.

EASY HANDLING



EASY TRANSPORT AND FAST SETUP CONCEPT

HIGH POWER



STUNNING POWER DENSITY AND HEADROOM

LONG THROW



LINE ARRAY DISPERSION PATTERN

MAILA APP

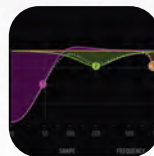

PROFESSIONAL SETUP ASSISTANCE TOOL (iPAdOS)

EASYSPLAY®



ONE-HAND SPLAY ANGLE ADJUSTMENT

SMARTLINK+®



EASY AND ELEGANT CABLE-FREE CONNECTION



SHORT SPECS:

System power (RMS):	7.5 kW
Frequency response (-6dB):	34 Hz - 20 kHz
Total Height:	2502 mm
Total Weight:	222 kg

COMPONENTS:

- 6X MAILA SAT (SATELLITE)
- 2X MAILA SPA (SATELLITE AMP)
- 2X MAILA SUB (SUBWOOFER)

ACCESSORIES INCLUDED:

- 2X MAILA DB (SPEAKER POLE)
- 2X MAILA SUB PC (PROTECTIVE COVER)
- 2X MAILA SUB CB (CASTOR BOARD)
- 2X MAILA FC1 (FLIGHTCASE 1)



MAILA[®] M

MAILA M is a full-blown full-range stereo system that sets new standards with its flexibility.

In the M configuration, MAILA delivers a total output of 10 kW and combines several acoustic concepts into a sound reinforcement solution that is unique to date: High power 2 x 15" bandpass subwoofer, column element with integrated DSP amplifier and coaxial satellite with line array functionality.

The result is a classic line array dispersion pattern with an impressive throw due to the height of the ground stack setup of up to 3 metres.

EASY HANDLING



EASY TRANSPORT AND
FAST SETUP CONCEPT

HIGH POWER



STUNNING POWER DENSITY
AND HEADROOM

LONG THROW

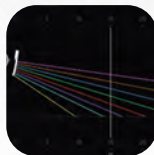

LINE ARRAY
DISPERSION PATTERN

MAILA APP

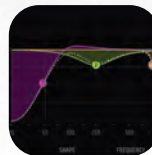

PROFESSIONAL SETUP
ASSISTANCE TOOL (iPAdOS)

EASYSPLAY[®]



ONE-HAND SPLAY
ANGLE ADJUSTMENT

SMARTLINK+[®]



EASY AND ELEGANT
CABLE-FREE CONNECTION



SHORT SPECS:

System power (RMS):	10 kW
Frequency response (-6dB):	34 Hz - 20 kHz
Total Height:	2920 mm
Total Weight:	293.2 kg

COMPONENTS:

- 8x MAILA SAT (SATELLITE)
- 2x MAILA COL (COLUMN)
- 2x MAILA SUB (SUBWOOFER)

ACCESSORIES INCLUDED:

- 2x MAILA SUB PC (PROTECTIVE COVER)
- 2x MAILA SUB CB (CASTOR BOARD)
- 2x MAILA FC2 (FLIGHTCASE 2)



MAILA® L

MAILA L is the largest ground stack stereo system in the MAILA family and delivers maximum power and punch for medium-sized live sound applications, clubs and corporate events when a flown setup is not possible for various reasons.

As a ground stack system, MAILA L sets new standards with its flexibility. Powered by a total output of 15 kW, MAILA L combines several acoustic concepts into a unique sound reinforcement solution: High power 2 x 15" bandpass subwoofer, column element with integrated DSP amplifier and coaxial satellite with line array functionality.

The result is a classic line array dispersion pattern with an impressive throw due to the height of the ground stack setup of over 3 metres.

EASY HANDLING



EASY TRANSPORT AND FAST SETUP CONCEPT

HIGH POWER



STUNNING POWER DENSITY AND HEADROOM

LONG THROW



LINE ARRAY DISPERSION PATTERN

MAILA APP

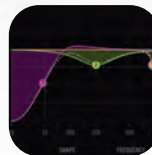

PROFESSIONAL SETUP ASSISTANCE TOOL (iPAdOS)

EASYSPLAY®



ONE-HAND SPLAY ANGLE ADJUSTMENT

SMARTLINK+®



EASY AND ELEGANT CABLE-FREE CONNECTION



SHORT SPECS:

System power (RMS):	15 kW
Frequency response (-6dB):	34 Hz - 20 kHz
Total Height:	3370 mm
Total Weight:	482.8 kg

COMPONENTS:

- 12X MAILA SAT (SATELLITE)
- 2X MAILA COL (COLUMN)
- 4X MAILA SUB (SUBWOOFER)

ACCESSORIES INCLUDED:

- 4X MAILA SUB PC (PROTECTIVE COVER)
- 4X MAILA SUB CB (CASTOR BOARD)
- 1X MAILA FC1 (FLIGHTCASE 1)
- 2X MAILA FC2 (FLIGHTCASE 2)



MAILA[®] XL

Some jobs require a big line array. For everything else, there is MAILA XL. For those who have the highest demands in terms of power, throw and even sound dispersion, yet do not want to forego easy handling and maximum flexibility, MAILA XL is a groundbreaking system for professional live sound applications, clubs and large conferences, which is also perfectly at home in theatres with its slim, cable-free design concept.

In contrast to the MAILA S, M and L ground stack systems, MAILA XL was primarily designed for flown applications, but can also be reconfigured into several ground stack systems with minimal additional investment.

Thus, MAILA XL does not present itself as “one” product, but as a scalable stereo sound reinforcement solution that sets new standards in its diversity and flexibility. Driven by a total power of 17.5 kW, MAILA XL combines several acoustic concepts in a unique way: bandpass subwoofer with cardioid setups, flown amplifier module with integrated DSP and coaxial satellites with line array functionality.

EASY HANDLING



EASY TRANSPORT AND FAST SETUP CONCEPT

HIGH POWER



STUNNING POWER DENSITY AND HEADROOM

LONG THROW

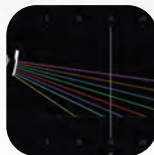

LINE ARRAY DISPERSION PATTERN

MAILA APP

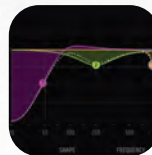

PROFESSIONAL SETUP ASSISTANCE TOOL (iPAdoS)

EASYSPLAY[®]



ONE-HAND SPLAY ANGLE ADJUSTMENT

SMARTLINK⁺



EASY AND ELEGANT CABLE-FREE CONNECTION



SHORT SPECS:

System power (RMS):	17.5 kW
Frequency response (-6dB)	34 Hz - 20 kHz
Total Height (Flying Array)	2200 mm
Total Weight:	672.4 kg

COMPONENTS:

16x MAILA SAT (SATELLITE)
2x MAILA SPA (SATELLITE AMP)
6x MAILA SUB (SUBWOOFER)

ACCESSORIES INCLUDED:

2x EASYMOUNT+® (TRUSS MOUNT)
6x MAILA SUB PC (PROTECTIVE COVER)
6x MAILA SUB CB (CASTOR BOARD)
2x MAILA FC3 (FLIGHTCASE 3)



MAILA[®] XXL

Some jobs require a big line array. For everything else, there is MAILA XXL. The largest and most powerful MAILA system with a total output of 20 kW is aimed at professional live sound users and rental service providers who place the highest demands on power, throw and even sound dispersion, yet do not want to forego easy handling and maximum flexibility. MAILA XXL is a groundbreaking system for professional live sound applications, clubs and large halls. With its slim, cable-free design concept, it is also perfect for theatres.

In contrast to the MAILA S, M and L ground stack systems, MAILA XXL was primarily designed for flown applications, but can also be reconfigured into a MAILA L ground stack system without additional investment, if required. Thus MAILA XXL does not present itself as “one” product, but as a scalable stereo sound reinforcement system that sets new standards in its diversity and flexibility.

MAILA XXL combines several acoustic concepts into a unique sound reinforcement solution: bandpass subwoofer with cardioid setup, column element with integrated DSP amplifier and coaxial satellites with line array functionality.

EASY HANDLING



EASY TRANSPORT AND FAST SETUP CONCEPT

HIGH POWER



STUNNING POWER DENSITY AND HEADROOM

LONG THROW



LINE ARRAY DISPERSION PATTERN

MAILA APP

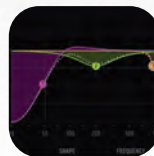

PROFESSIONAL SETUP ASSISTANCE TOOL (IPADOS)

EASYSPLAY[®]



ONE-HAND SPLAY ANGLE ADJUSTMENT

SMARTLINK+[®]



EASY AND ELEGANT CABLE-FREE CONNECTION



SHORT SPECS:

System power (RMS):	20 kW
Frequency response (-6dB)	34 Hz - 20 kHz
Total Height (Flying Array)	2730 mm
Total Weight:	782 kg

COMPONENTS:

16x MAILA SAT (SATELLITE)
2x MAILA COL (COLUMN)
6x MAILA SUB (SUBWOOFER)

ACCESSORIES INCLUDED:

2x EASYMOUNT+® (TRUSS MOUNT)
6x MAILA SUB PC (PROTECTIVE COVER)
6x MAILA SUB CB (CASTOR BOARD)
2x MAILA FC2 (FLIGHTCASE 2)
1x MAILA FC3 (FLIGHTCASE 3)



MAILA[®] SAT

PASSIVE ARRAY SATELLITE SPEAKER

The MAILA SAT satellite speaker is a true line array element and is full of surprises. The elegant and robust unibody aluminium enclosure includes five 1" tweeters in front of a 6.5" midrange driver, arranged in a coaxial design based on Advanced WaveAhead[®] technology and coupled almost interference-free via the SonicGuide[®] (two combined waveguides). The result is a classic line array radiation pattern with impressive throw and energy density.

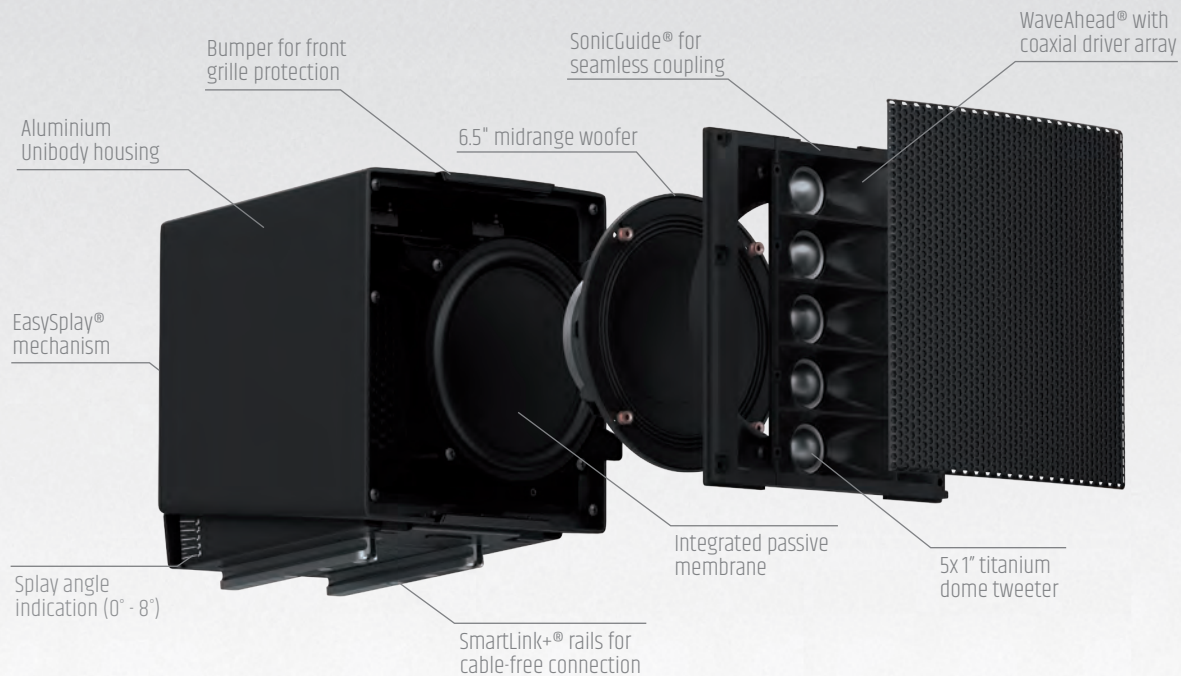

WATCH THE SATELLITE VIDEO

MAILA® SPA

POWER AMPLIFIER FOR UP TO EIGHT SATELLITES

MAILA SPA is the only MAILA module without integrated loudspeakers - and yet an integral part of the MAILA concept. This amplifier module in elegant unibody aluminium design with integrated 1.25 kW power amplifier features LD Systems' SysCore® DSP and can power up to eight MAILA SAT satellites. Via the SmartLink+® system, the satellites can be simply slid onto the SPA and wirelessly supplied with audio and power. In addition, SmartLink+® enables automatic detection of the installed satellites for automatic or manual DSP processing.

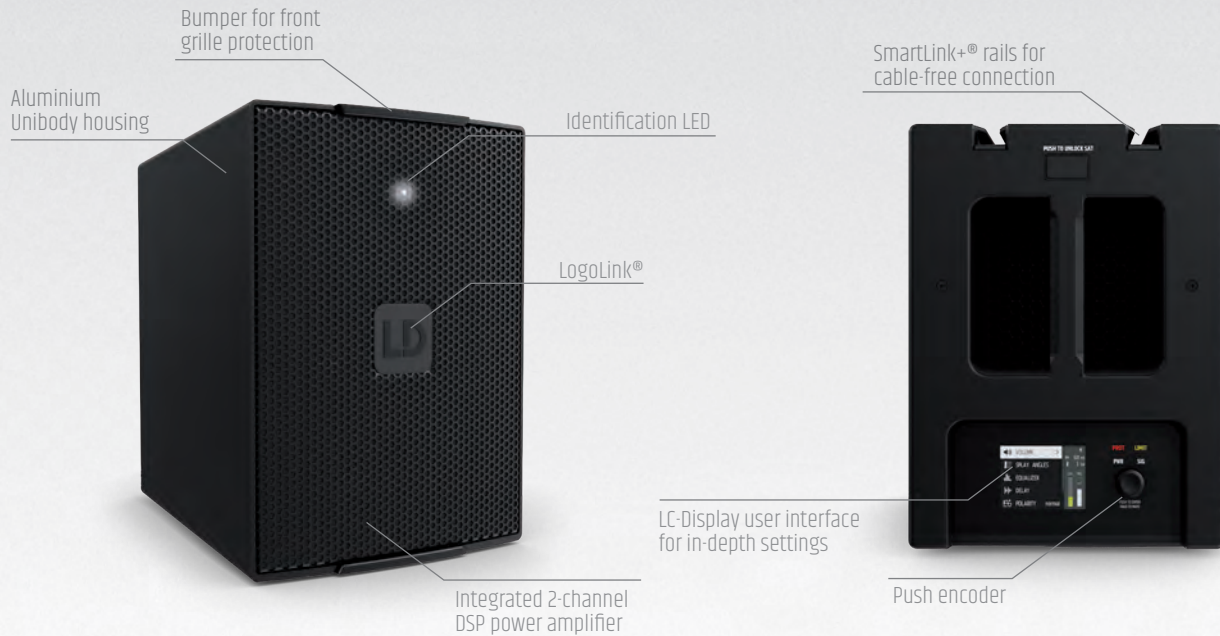

WATCH THE SATELLITE POWER AMPLIFIER VIDEO



MAILA[®] COL

4 X 6.5" POWERED COLUMN SPEAKER + POWER AMPLIFIER FOR UP TO EIGHT SATELLITES

The MAILA COL full-range column module makes MAILA truly versatile. With its 4x 6.5" woofers, the elegant column element not only provides an extended low-mid range, but also includes a 4-channel DSP amplifier with 2.5 kW total power, which drives both the column itself and the MAILA SAT satellites. In this way, MAILA sets with column module can not only be used as a ground stack variant, but also as a flown array consisting of MAILA COL and up to eight MAILA SAT - especially useful for festivals and fixed installations. In addition, as with a classic line array, users can select different subwoofer arrangements and adapt them to the sound reinforcement requirements on site.

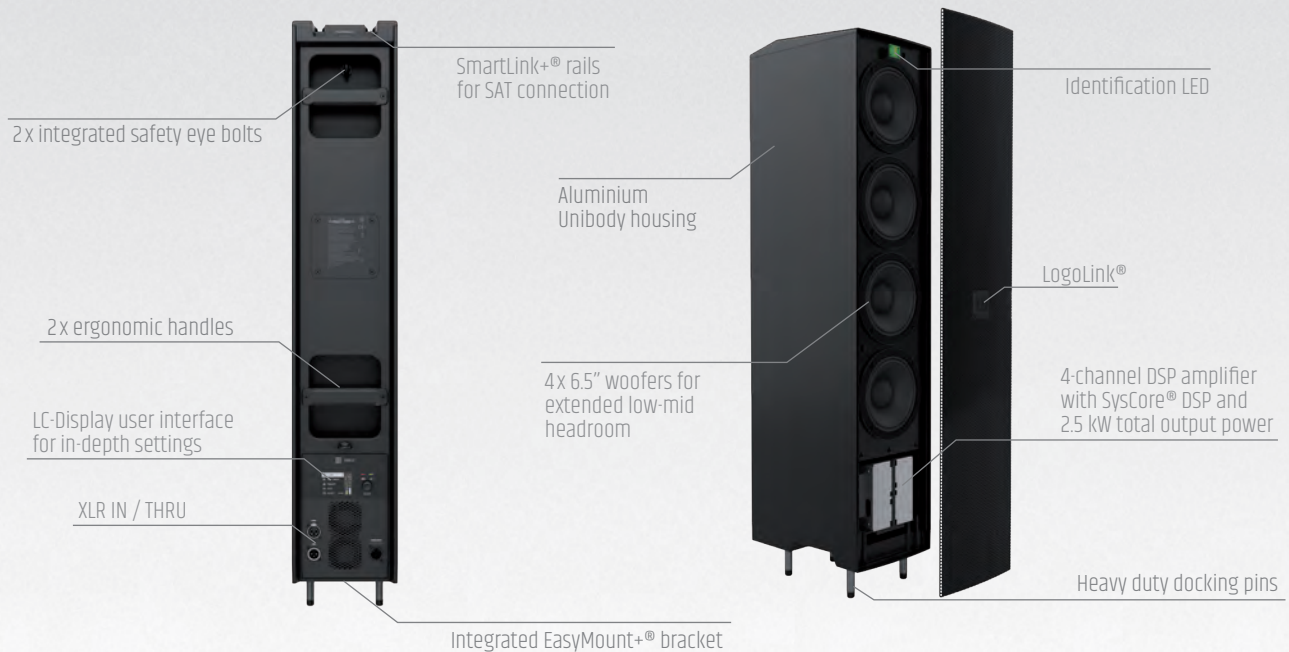

WATCH THE COLUMN VIDEO

MAILA® SUB

2 X 15" POWERED BANDPASS PA SUBWOOFER

MAILA SUB forms the basis of every MAILA system. The 2.5 kW 2 x 15" high-performance subwoofer features a bandpass design and, with its newly developed SysCore® DSP, delivers a massive and powerful bass foundation in any application. The acoustic concept of the MAILA SUB is based on a planar wave bandpass design with quarter-wave horn and symmetrical driver construction. By placing the two 15" speakers opposite each other, the MAILA SUB enables exceptional impulse compensation, resulting in a powerful and precise low-frequency punch.

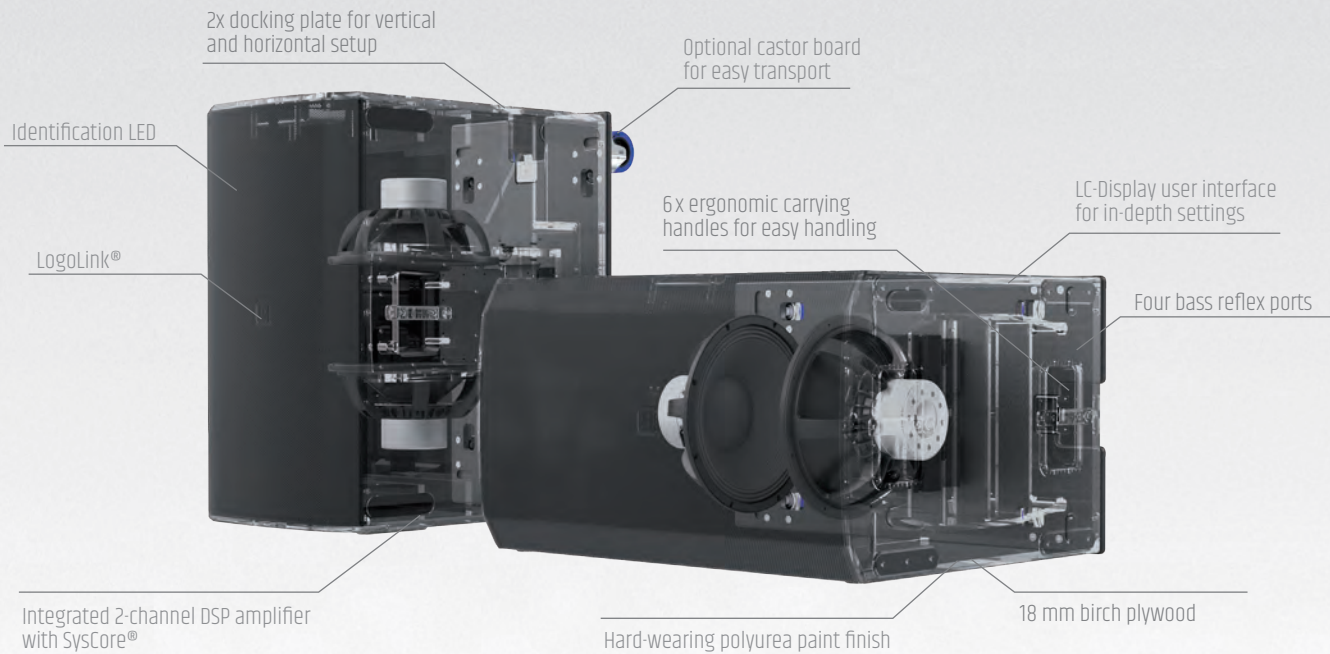

WATCH THE SUBWOOFER VIDEO



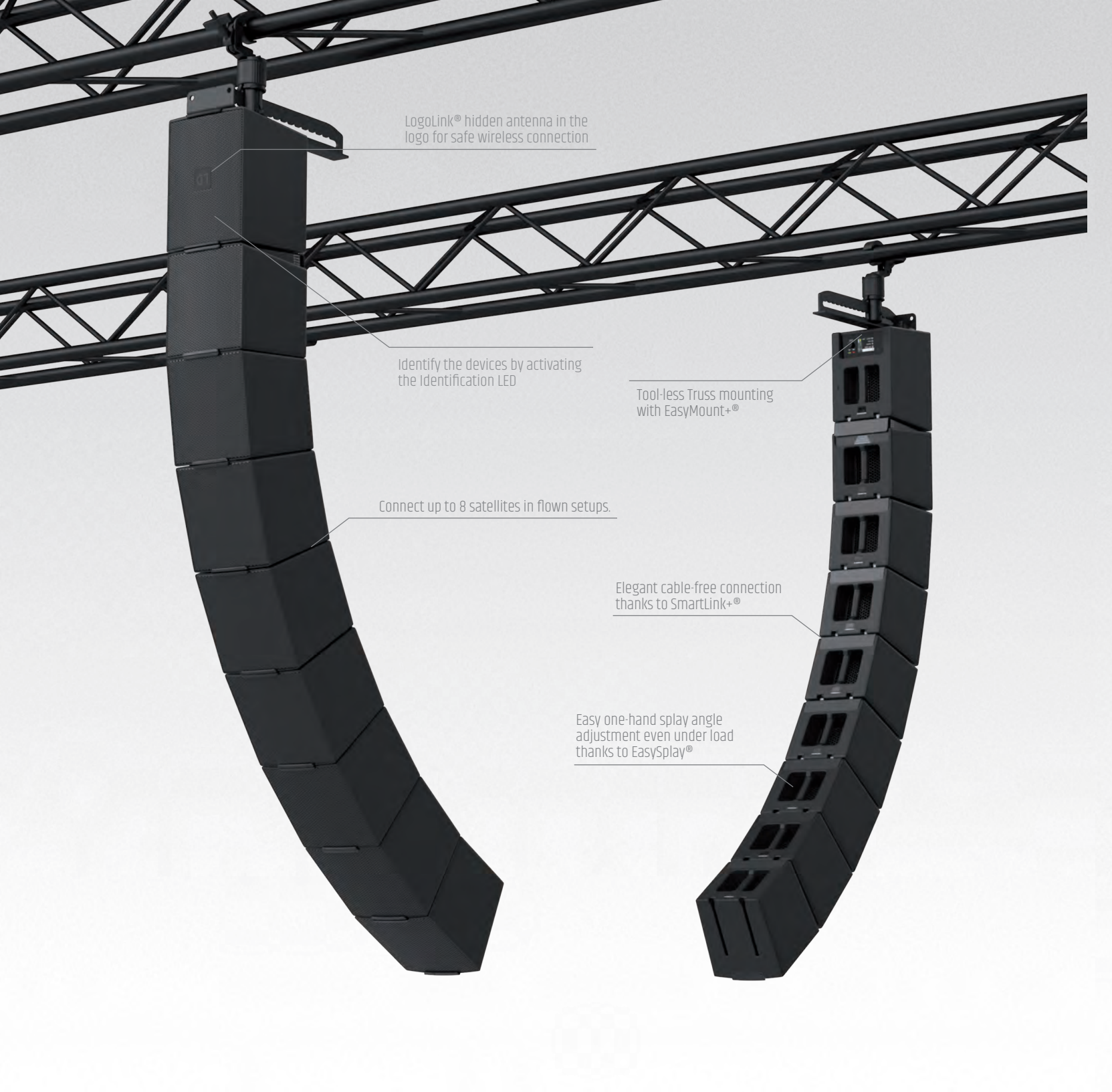

LogoLink® hidden antenna in the logo for safe wireless connection

Identify the devices by activating the Identification LED

Connect up to 8 satellites in flown setups.

Tool-less Truss mounting with EasyMount+®

Elegant cable-free connection thanks to SmartLink+®

Easy one-hand splay angle adjustment even under load thanks to EasySplay®



SERIOUSLY CLEVER

On top of its unique design and sophisticated acoustic signature, MAILA stands out for its various clever details, designed by our engineers to make the working lives of event technicians easier and safer.

WATCH ALL CLEVER DETAILS



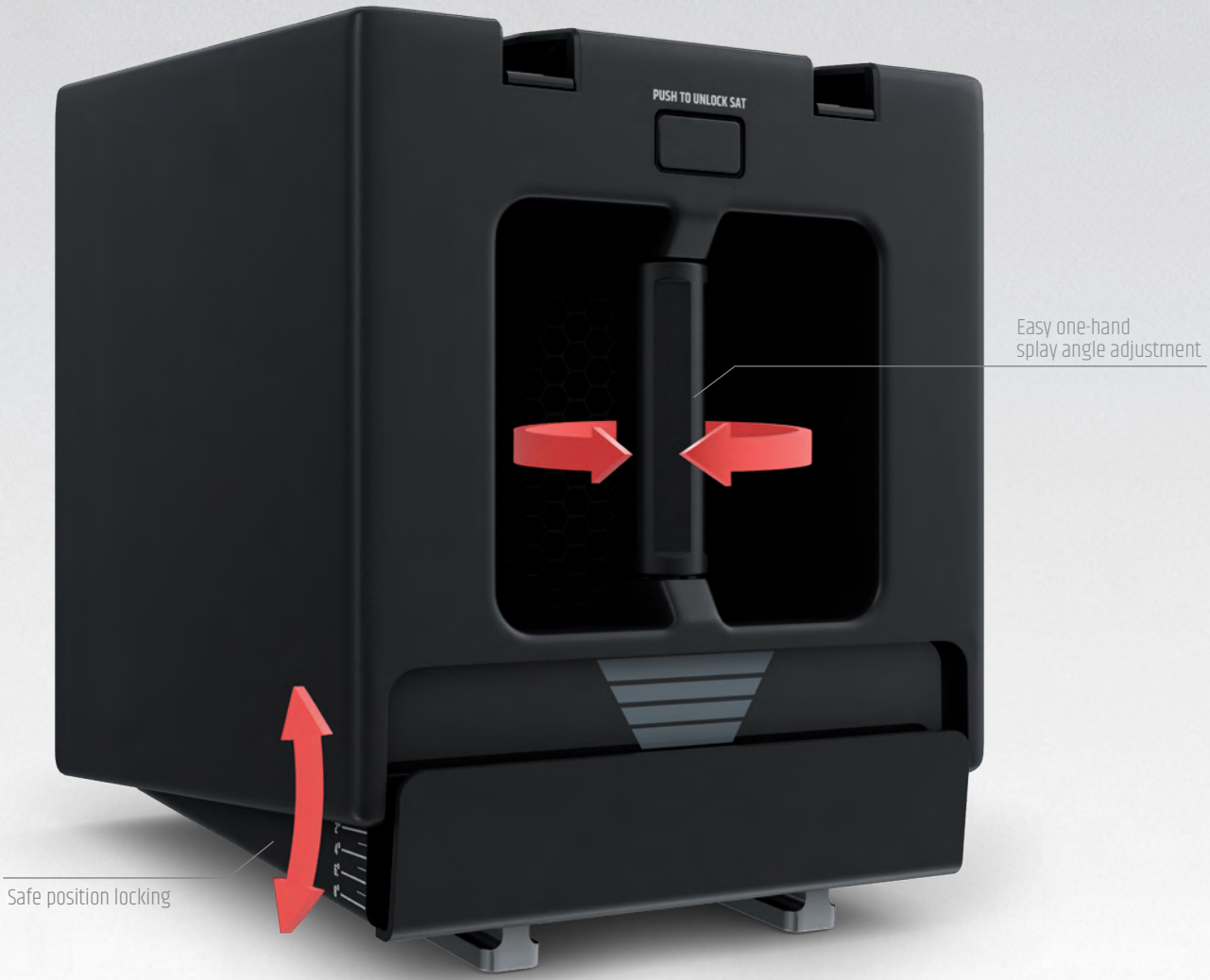

PUSH TO UNLOCK SAT

Easy one-hand
splay angle adjustment

Safe position locking

EASYSPLAY[®] MECHANISM

On the back of the housing of each MAILA SAT is a rotating handle which hides a groundbreaking innovation: via the patented EasySplay[®] mechanism, users can adjust the inclination of each individual satellite continuously from 0° to 8° in the blink of an eye. The angle can be adjusted with just one hand, even under load. In this way, every MAILA system offers a uniquely flexible concept for adapting the sound coverage to any sound reinforcement situation at any time.

WATCH THE EASYSPLAY[®] VIDEO

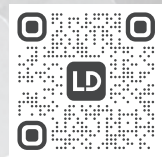

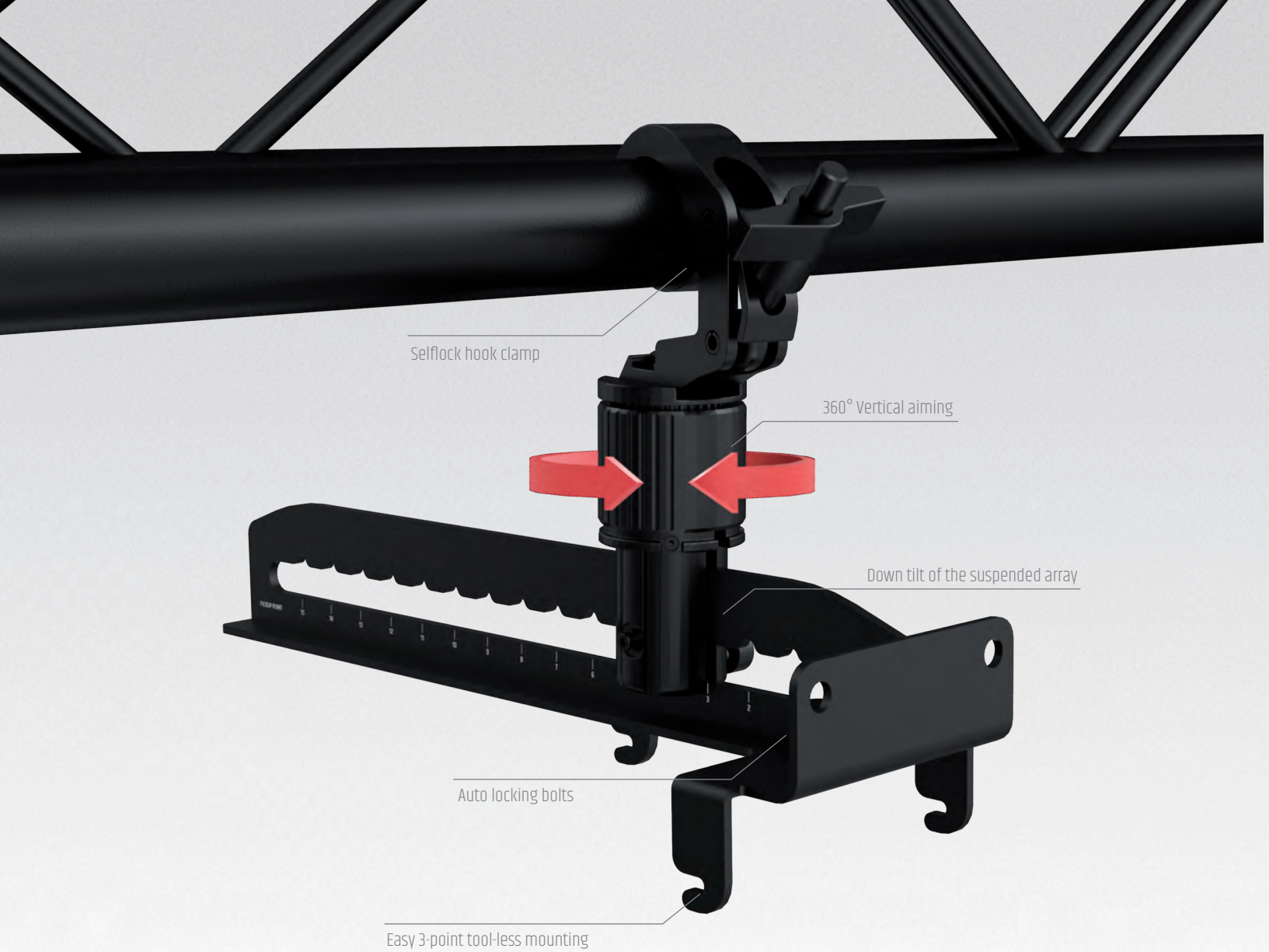

Selflock hook clamp

360° Vertical aiming

Down tilt of the suspended array

Auto locking bolts

Easy 3-point tool-less mounting

Patent Technology: (Patent No. DE202017100219U1 & U10,681,440)

MAILA **EASYMOUNT+**[®]

Truss mount bracket for MAILA[®]

Work faster and safer with EasyMount+[®], MAILA's dedicated truss rigging hardware. Its innovative, tool-less design ensures maximum safety in handling as well as hassle-free and precise alignment of the line array.

WATCH THE EASYMOUNT+[®] VIDEO





Robust aluminium construction

Cable-free connection

Automatic detection of the number of satellites installed

Secure lock mechanism

SMARTLINK+[®] CONNECTION

For an especially easy setup, the passive MAILA SAT array satellites are equipped with the LD Systems SmartLink+[®] system, which ensures a cable-free connection between the MAILA SAT modules as well as between MAILA SAT and MAILA SPA amplifier module or MAILA COL column module.

Both the audio signal and the power supply for the passive MAILA elements are provided via the robust aluminium rails. In addition, SmartLink+[®] allows the installed satellites to be detected for automatic or manual DSP processing.

WATCH THE SMARTLINK+[®] VIDEO





ROOM SIMULATION

Auto EQ adjustment of your system and calculation of the required splay angle based on room length and height of installation of the satellite array.



PRE-PLANNING

Optimal set up in advance from the office as well as on site, right before an event.



10 BAND EQ PRESETS

The MAILA app includes a parametric 10 band eq in which the settings can be saved as presets.

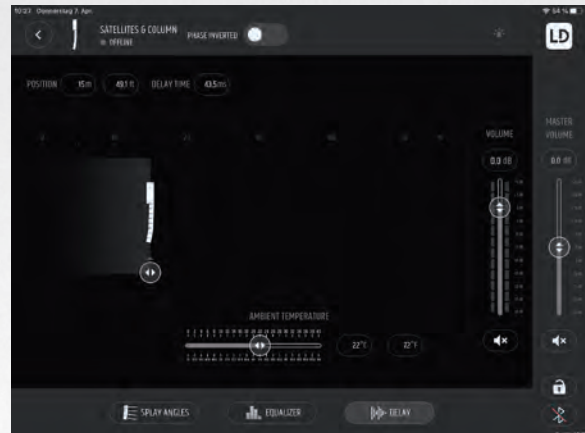

DELAY LINES

Automatic calculation of the required DSP adjustments for delay lines based on distance from main PA, room temperature and more.

MAILA APP FOR QUICK SETUP

Via the free MAILA app (iPadOS), every MAILA system can be adapted quickly, easily and precisely and supplied with software updates wirelessly. Based on the integrated LogoLink® Wireless Connection, operating ranges of up to 30 metres under practical conditions are no problem for MAILA. Once connected, the app automatically detects the available MAILA components and enables the system to be set up quickly and easily - including calculation of the SAT angles - in the run-up to an event. The highlight: the wireless antennas are invisibly integrated into the LD logos (LogoLink®).

MORE ABOUT THE MAILA APP





SYSCORE[®] DSP

SYSTEM FIXED:

- FIR / IIR EQ & Crossover
- Time Alignment
- RMS Limiter
- Multiband Peak Limiter
[Linear Phase - SPA & Column]
- Thermal Protection Limiter
- Over Excursion Limiter
- SMPS Overload Limiter
- Automatic Satellite EQ
[1-8 Sats - SPA & Column]

USER ACCESSIBLE:

- User EQ (10 Band Parametric)
- Delay (55m max.)
- Polarity
- Crossover Preset selection
[incl Cardioid Preset - SUB]
- Level
- Mute

MAILA® SPECIFICATIONS

Product type	MAILA Array Satellite
Art. No.	LDMAILASAT
Midrange dimensions	5 x 1" Titanium Dome Tweeter
Woofers dimensions	1 x 6,5"
Woofers magnet	Neodymium
Woofers brand	Custom made
Woofers voice coil	1.8" / 45 mm
Load rating (AES)	175 W / 50 W
Dispersion (H x V)	100° x 8° Nominal Directivity
Frequency response (-6dB)	100 Hz - 20000 Hz
Max. SPL Peak (Pink noise)	129.1 dB (fullspace @1m, Crest factor 4)
Max. SPL Peak (Sine burst)	128.2 dB (fullspace @1m, 10% THD)
Max. SPL Average (Sine burst)	115 dB (100 Hz - 10 kHz, fullspace @1m, 10% THD)
Impedance	16/320hm
Controls	EasySplay® angle adjustment
Loudspeaker Output Connectors	SmartLink+®
Cabinet material	Die-cast aluminium
Cabinet surface	Powder-coated
Handles	1
Width	205 mm
Height	234 mm
Depth	226 mm
Weight	7.65 kg

Product type	MAILA Satellite Amplifier
Art. No.	LDMAILASPA
Amplifier	Class D
System Power (RMS)	1250 W
Protection circuits	Limiter, over-current, thermal overload
Input impedance	20000 Ohm(s)
Controls	Rotary/push encoder
Indicators	LC display, LED indicator, Limit, Power, Protect, Signal
Line input connectors	1x XLR
Line output connectors	1x XLR
Speaker output connections	SmartLink+®
Wireless Connectivity	LogoLink® for App Control
Operating voltage	100 - 240 V AC, 50 - 60 Hz, SMPS
Power consumption (max.)	400 W
Operating Temperature	0 - 40°C
Relative Humidity	< 80 %, not condensing
Cabinet material	Die-cast aluminium unibody
Cabinet surface	Powder-coated
Mounting	2 x M10, 25 mm MAILA Flange, EasyMount+®
Handles	1
Width	205 mm
Height	282 mm
Depth	226 mm
Weight	7.45 kg
DSP Characteristic	
Bit depth AD/DA converter	24 Bit
Sampling frequency	48 kHz

Product type	MAILA Column
Art. No.	LDMAILACOL
Woofers dimensions	4 x 6,5"
Woofers magnet	Neodymium
Woofers brand	Custom made
Woofers voice coil	2" / 50 mm
Amplifier	Class D
RMS	2500 W
Frequency response (-6dB)	105 Hz - 500 Hz
Max. SPL Peak (Pink noise)	130 dB (fullspace @1m, Crest factor 4)
Max. SPL Peak (Sine burst)	125.4 dB (fullspace @1m, 10% THD)
Max. SPL Average (Sine burst)	122 dB (100 Hz - 2 kHz, fullspace @1m, 10% THD)
Protection circuits	Limiter, over-current, thermal overload
Input impedance	20000 Ohm(s)
Controls	Rotary/push encoder
Indicators	Indication LED, LC display, Limit, Power, Protect, Signal
Line input connectors	1x XLR
Line output connectors	1x XLR
Loudspeaker Output Connectors	SmartLink+®
Wireless Connectivity	LogoLink® for App Control
Operating voltage	100 V AC - 240 V AC, 50 - 60 Hz
Power consumption (max.)	800 W
Operating Temperature	0 - 40°C
Relative Humidity	< 80 %, not condensing
Cabinet material	Die-cast aluminium unibody
Cabinet surface	Powder-coated
Cabinet construction	Bass Reflex
Mounting	3 x M10, 4 x Pin, EasyMount+®
Handles	2
Width	205 mm
Height (incl. Pins)	968 mm (1028 mm)
Depth	354 mm
Weight	36.195 kg
DSP Characteristic	
Bit depth AD/DA converter	24 Bit
Sampling frequency	48 kHz

Product type	MAILA Subwoofer
Art. No.	LDMAILASUB
Woofers dimensions	2 x 15"
Woofers magnet	Neodymium
Woofers brand	Custom made
Woofers voice coil	4" / 100 mm
Amplifier	Class D
RMS	2500 W
Frequency response (-6dB)	33 Hz - Preset
Max. SPL Peak (Pink noise)	131 dB (fullspace @1m, Crest factor 4)
Max. SPL Peak (Sine burst)	127.4 dB (fullspace @1m, 10% THD)
Max. SPL Average (Sine burst)	126 dB (50 Hz - 120 Hz, fullspace @1m, 10% THD)
Protection circuits	Limiter, over-current, thermal overload
Input impedance	20000 Ohm(s)
Controls	On/off switch, Rotary/push encoder
Indicators	Indication LED, LC display, Limit, Power, Protect, Signal
Line input connectors	1x XLR
Line output connectors	1x XLR
Wireless Connectivity	LogoLink® for App Control
Operating voltage	100 V AC - 240 V AC, 50 - 60 Hz
Power consumption (max.)	1300 W
Operating Temperature	0 - 40°C
Relative Humidity	< 80 %, not condensing
Cabinet material	18 mm Birch Plywood
Cabinet surface	Polyurea
Cabinet construction	Quarter Wave Horn Bandpass
Handles	6
Width	540 mm
Height	934 mm
Depth	803 mm
Weight	89,8 kg
DSP Characteristic	
Bit depth AD/DA converter	24 Bit
Sampling frequency	48 kHz

RATE PAYMENT (EU ONLY)

To support the restart of our industry we have put together a very attractive rate payment option for our customers within the European Union. This financial “product” is a 100% Adam Hall solution without the participation of any third-party financial institute and was designed as a **“pay as you earn”** payment option.

Contact our Adam Hall sales team for more details!



BOOK A MAILA[®] DEMO

You have read and watched everything there is to see on our website "www.ld-systems.com/mailla" and you are ready to experience the MAILA concept in the flesh? Then you reached the right spot. The MAILA team offers demo slots on a regular basis. They are open to everyone who wishes to hear and experience MAILA first-hand, so feel free and register for the next available appointment.

We are looking forward to welcoming you at the Adam Hall Experience Center!



www.ld-systems.com/mailla-demo

LDsystems 
your sound. our mission.

MAILA[®] SERIES

MODULAR ALL-ROUND
INTELLIGENT LINE ARRAY



Carbon neutral
Print product
ClimatePartner.com/10831-2208-1001

MKBMALD



LD-SYSTEMS.COM/MAILA

LD Systems[®] is a registered brand of the Adam Hall Group.